

Single P-Channel MOSFET

DESCRIPTION

STP3407S is the P-Channel trench technology devices are well suited for high efficiency fast switching applications, low in-line power loss needed in small outline surface mount package.

PART NUMBER INFORMATION

STP 3407 S - TR G
 a b c d e

- a : Company name.
- b : Product Serial number.
- c : Package code S: SOT-23L
- d : Handling code TR: Tape&Reel
- e : Green produce code G: *RoHS Compliant*

FEATURES

$V_{DS}=-30V$, $I_D=-4.3A$

$R_{DS(ON)}=38m\Omega(Typ.)@V_{GS}=-10V$
 $R_{DS(ON)}=58m\Omega(Typ.)@V_{GS}=-4.5V$

APPLICATIONS

- ◆ Portable Equipment
- ◆ Power Management
- ◆ Load Switch

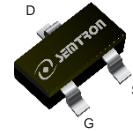

SOT-23L

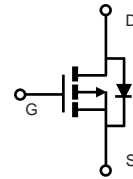

ABSOLUTE MAXIMUM RATINGS ($T_A=25^{\circ}C$ Unless otherwise noted)

Symbol	Parameter	Rating	Units	
V_{DSS}	Drain-Source Voltage	-30	V	
V_{GSS}	Gate-Source Voltage	± 20	V	
I_D	Continuous Drain Current ^A	$T_A=25^{\circ}C$	-4.3	A
		$T_A=70^{\circ}C$	-3.6	A
I_{DM}	Pulsed Drain Current ^B	-20	A	
P_D	Power Dissipation ^A	$T_A=25^{\circ}C$	1.5	W
		$T_A=70^{\circ}C$	0.9	W
T_J	Operation Junction Temperature	-55/150	$^{\circ}C$	
T_{STG}	Storage Temperature Range	-55/150	$^{\circ}C$	

THERMAL RESISTANCE

Symbol	Parameter	Typ	Max	Units
$R_{\theta JA}$	Thermal Resistance Junction to Ambient ^A	$t \leq 10s$	85	$^{\circ}C/W$
	Thermal Resistance Junction to Ambient ^{AC}	Steady-State	120	

ELECTRICAL CHARACTERISTICS ($T_A=25^\circ\text{C}$ Unless otherwise noted)

Symbol	Parameter	Condition	Min	Typ	Max	Unit
Static Parameters						
BV _{DSS}	Drain-Source Breakdown Voltage	V _{GS} =0V, I _D =-250 μ A	-30			V
V _{GS(th)}	Gate Threshold Voltage	V _{DS} =V _{GS} , I _D =-250 μ A	-1	-1.5	-2	V
I _{GSS}	Gate Leakage Current	V _{DS} =0V, V _{GS} = \pm 20V			\pm 100	nA
I _{DSS}	Zero Gate Voltage Drain Current	V _{DS} =-30V, V _{GS} =0V, T _J =25 $^\circ$ C			-1	μ A
		V _{DS} =-24V, V _{GS} =0V, T _J =75 $^\circ$ C			-10	
R _{DS(ON)}	Drain-source On-Resistance ^D	V _{GS} =-10V, I _D =-4.3A V _{GS} =-4.5V, I _D =-3A		38 58	45 68	m Ω
G _{fs}	Forward Transconductance	V _{DS} =-10V, I _D =-4.3A		11		S
Diode Characteristics						
V _{SD}	Diode Forward Voltage ^D	I _S =-1A, V _{GS} =0V		-0.7	-1	V
I _S	Diode Continuous Forward Current				-4.3	A
Dynamic and Switching Parameters ^E						
Q _g	Total Gate Charge	V _{DS} =-15V, V _{GS} =-10V I _D =-4.3A		12.3		nC
Q _g	Total Gate Charge(4.5V)			6		
Q _{gs}	Gate-Source Charge			2.7		
Q _{gd}	Gate-Drain Charge			3.1		
C _{iss}	Input Capacitance	V _{DS} =-25V, V _{GS} =0V, f=1MHz		645		pF
C _{oss}	Output Capacitance			272		
C _{rss}	Reverse Transfer Capacitance			105		
t _{d(on)}	Turn-On Time	V _{DD} =-15V, V _{GEN} =-10V R _G =3.3 Ω , I _D =-4A		9		nS
t _r				16.5		
t _{d(off)}	Turn-Off Time			22		
t _f				21		

Note: Absolute maximum ratings are those values beyond which the device could be permanently damaged.

- A. Surface mounted on FR4 board using 1 in² pad size.
- B. Pulsed width limited by maximum junction temperature, T_{J(MAX)}=150 $^\circ$ C (initial temperature T_J=25 $^\circ$ C).
- C. Using \leq 10s junction-to-ambient thermal resistance is base on T_{J(MAX)}=150 $^\circ$ C.
- D. Pulse test width \leq 300 μ s and duty cycle \leq 2%.
- E. Guaranteed by design, not subject to production testing.

The products and product specifications contained herein are subject to change without notice to improve performance characteristics. Consult us, or our representatives before use, to confirm that the information in this datasheet is up to date. We assume no responsibility for any infringement of patents, patent rights, or other rights arising from the use of any information and circuitry in this datasheet.

TYPICAL CHARACTERISTICS

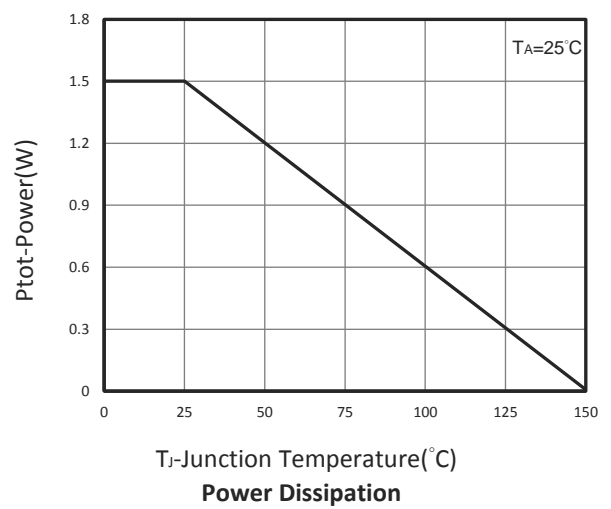
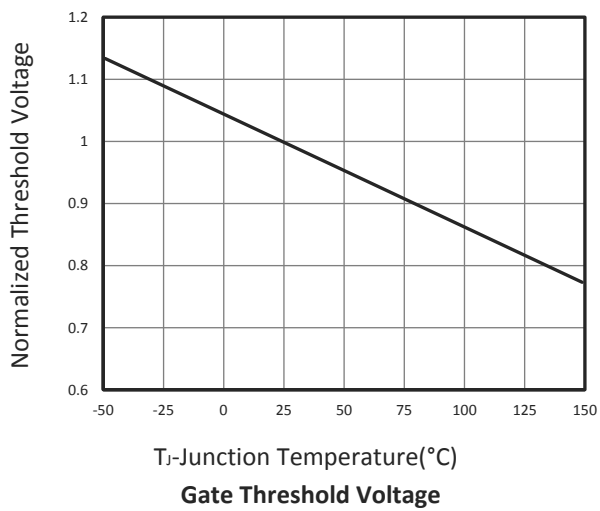
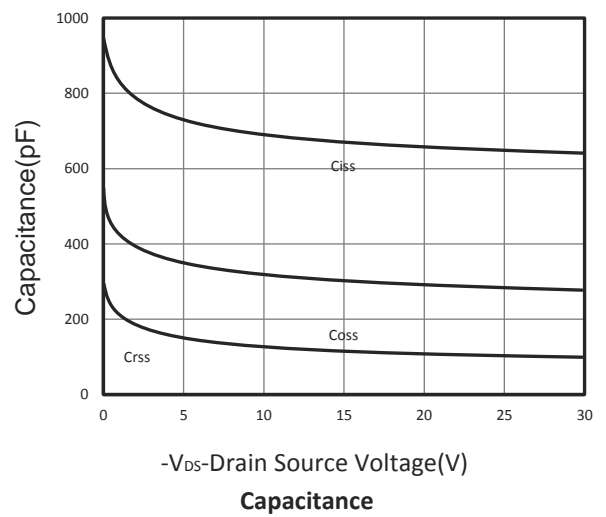
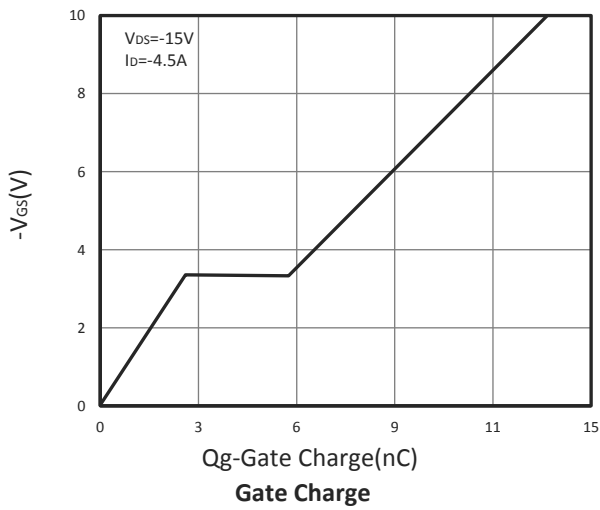
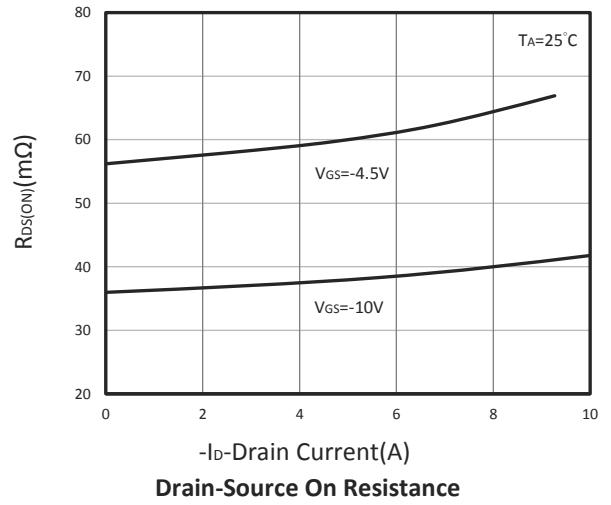
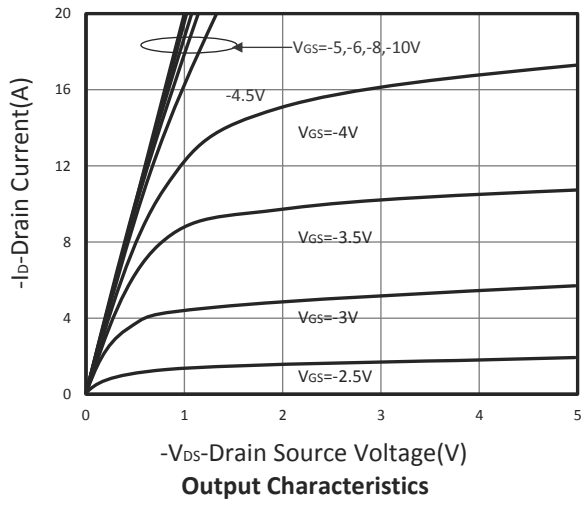

TYPICAL CHARACTERISTICS

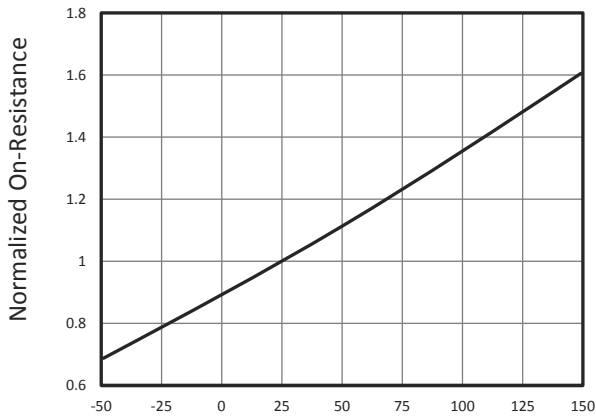

T_J-Junction Temperature(°C)
Drain-Source On Resistance

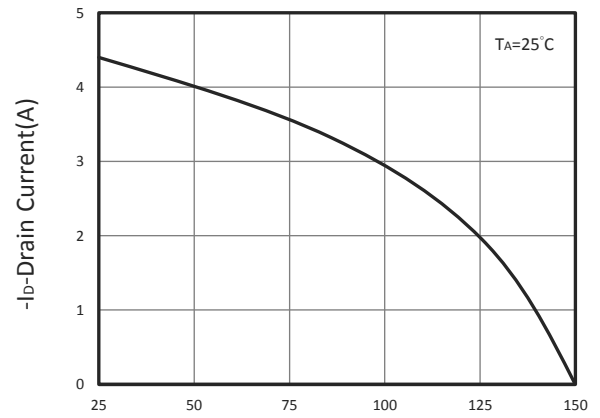

T_J-Junction Temperature(°C)
Drain Current vs T_J

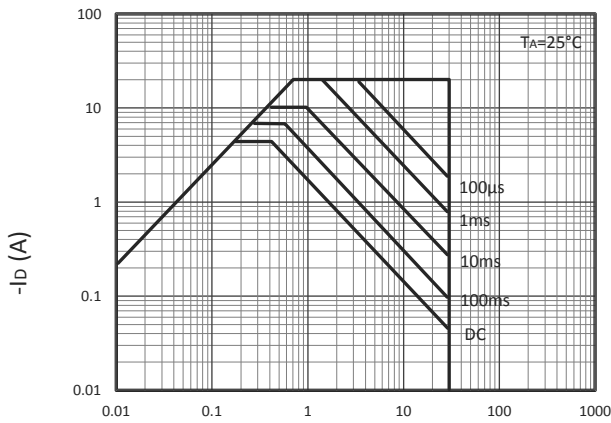

- V_{DS} Voltage (V)
Maximum Safe Operation Area

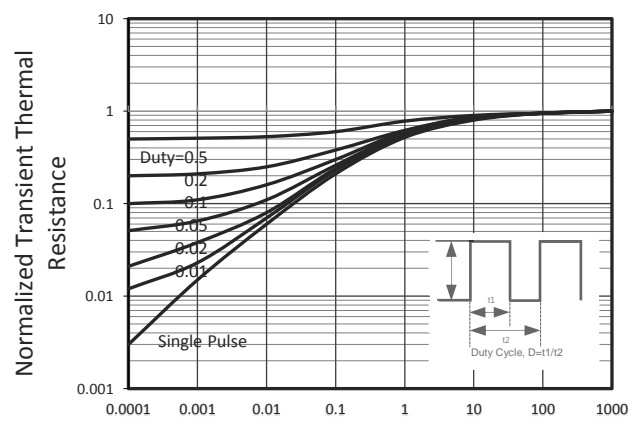

Square Wave Pulse Duration(Sec)
Thermal Transient Impedance

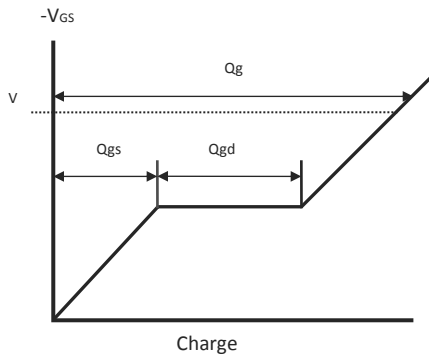

Gate Chrg Waveform

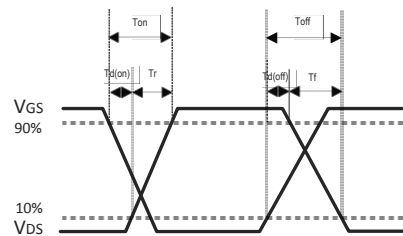

Switching Time Waveform

■ SOT-23L PACKAGE DIMENSIONS

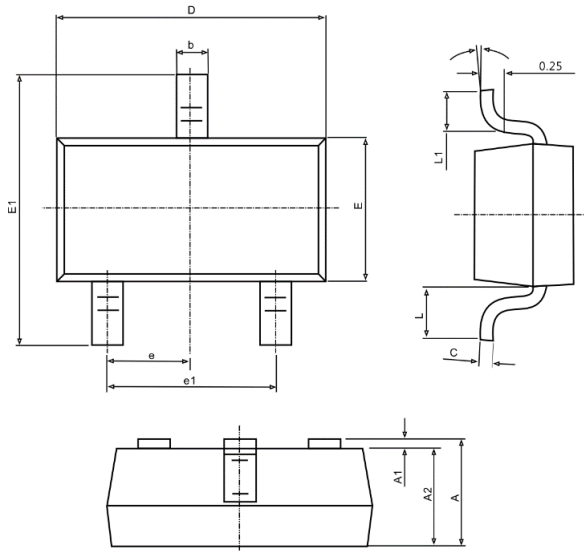

Recommended Minimum Pad(mm)

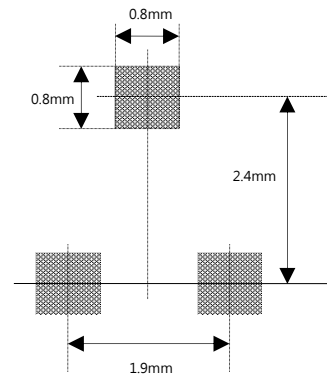

Symbol	Dimensions In Millimeters		Dimensions In Inches	
	Min.	Max.	Min.	Max.
A	1.000	1.300	0.039	0.049
A1	0.000	0.100	0.000	0.004
A2	1.000	1.200	0.039	0.047
b	0.300	0.500	0.012	0.020
c	0.047	0.207	0.002	0.008
D	2.800	3.000	0.110	0.118
E	1.500	1.700	0.059	0.067
E1	2.600	3.000	0.102	0.118
e	0.950 TYP.		0.037 TYP.	
e1	1.900 TYP.		0.075 TYP.	
L1	0.250	0.550	0.010	0.022
θ	0°	8°	0°	8°