

20V N-Channel Enhancement Mode MOSFET

DESCRIPTION

The STN2302 is the N-Channel logic enhancement mode power field effect transistor is produced using high cell density. advanced trench technology to provide excellent $R_{DS(ON)}$. low gate charge and operation gate as 1.8V.

This device is suitable for use as a load switch or other general applications.

STN2302S-TRG ROHS Compliant This is Halogen Free

FEATURE

- ◆ **20V/4.0A, $R_{DS(ON)} = 50m\Omega(typ.)@V_{GS} = 4.5V$**
- ◆ **20V/3.0A, $R_{DS(ON)} = 65m\Omega(typ.)@V_{GS} = 2.5V$**
- ◆ Super high density cell design for extremely low Gate Charge
- ◆ Exceptional on-resistance and Maximum DC current capability

APPLICATIONS

- ◆ Power Management in Note book
- ◆ Portable Equipment
- ◆ Load Switch



N-Channel Enhancement Mode MOSFET

PIN CONFIGURATION

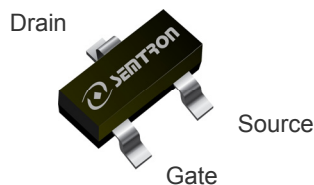

SOT-23
Top View

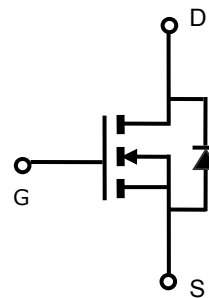

PART NUMBER INFORMATION

$\frac{\text{ST}}{a} \frac{\text{N}}{b} \frac{\text{2302}}{c} \frac{\text{S}}{d} - \frac{\text{TR}}{e} \frac{\text{G}}{f}$	<p>a : Company name. b : Channel type. c : Product Serial number. d : Package code e : Handling code f : Green product code</p>
--	--

ORDERING INFORMATION

Part Number	Package Code	Handling Code	Shipping
STN2302S-TRG	S : SOT-23	TR : Tape&Reel	3K/Reel

- ※ Year Code : 0 ~ 9, 2010 : 0
- ※ Week Code : A(1~2) ~ Z(53~54)
- ※ SOT-23 : Only available in tape and reel packaging.

ABSOLUTE MAXIMUM RATINGS (T_A = 25°C Unless otherwise noted)

Symbol	Parameter	Typical	Unit
V _{DSS}	Drain-Source Voltage	20	V
V _{GSS}	Gate-Source Voltage	±12	V
I _D	Continuous Drain Current (T _C =25°C) ^A	V _{GS} =4.5V	4.6
	Continuous Drain Current (T _C =70°C) ^A		3.8
I _{DM}	Pulsed Drain Current ^B	14	A
P _D	Power Dissipation	T _A =25°C	1.0
		T _A =70°C	0.7
T _J	Operation Junction Temperature	-55 to 150	°C
T _{STG}	Storage Temperature Range	-55 to 150	°C

Note: Absolute maximum ratings are those values beyond which the device could be permanently damaged.
 Absolute maximum ratings are stress ratings only and functional device operation is not implied.

THERMAL DATA

Symbol	Parameter	Typ	Max	Unit	
R _{θJA}	Thermal Resistance-Junction to Ambient ^A	Steady-State	-	125	°C/W
R _{θJC}	Thermal Resistance Junction to Lead ^A	Steady-State	-	85	°C/W

ELECTRICAL CHARACTERISTICS ($T_A = 25^\circ\text{C}$ Unless otherwise noted)

Symbol	Parameter	Condition	Min	Typ	Max	Unit
Static Parameters						
$V_{(BR)DSS}$	Drain-Source Breakdown Voltage	$V_{GS}=0V, I_D=250\mu A$	20			V
$V_{GS(th)}$	Gate Threshold Voltage	$V_{DS}=V_{GS}, I_D=250\mu A$	0.5		1.0	V
I_{GSS}	Gate Leakage Current	$V_{DS}=0V, V_{GS}=\pm 12V$			± 100	nA
I_{DSS}	Zero Gate Voltage Drain Current	$V_{DS}=20V, V_{GS}=0V$			1	μA
		$V_{DS}=20V, V_{GS}=0V$ $T_J=55^\circ\text{C}$			5	
$R_{DS(ON)}$	Drain-source On-Resistance ^B	$V_{GS}=4.5V, I_D=4.0A$		40	50	m Ω
		$V_{GS}=2.5V, I_D=3.0A$		54	75	
G_{fs}	Forward Transconductance	$V_{DS}=5V, I_D=3A$		10.5		S
Source-Drain Diode						
V_{SD}	Diode Forward Voltage	$I_S=1.0A, V_{GS}=0V$		0.7	1.2	V
I_S	Continuous Source Current ^{AD}				3.6	A
Dynamic Parameters						
Q_g	Total Gate Charge	$V_{DS}=10V$ $V_{GS}=4.5V$ $I_D=3.0A$		4.7	6.6	nC
Q_{gs}	Gate-Source Charge			0.68	0.96	
Q_{gd}	Gate-Drain Charge			1.3	1.8	
C_{iss}	Input Capacitance	$V_{DS}=15V$ $V_{GS}=0V$ $f=1\text{MHz}$		296	415	pF
C_{oss}	Output Capacitance			44	62	
C_{rss}	Reverse Transfer Capacitance			35	49	
$t_{d(on)}$	Turn-On Time	$V_{DD}=10V$ $I_D=3.0A$		1.4	2.8	nS
t_r				40	72	
$t_{d(off)}$	Turn-Off Time	$V_{GEN}=4.5V$ $R_G=3.3\Omega$		12.4	25	
t_f				5.6	11	

Note:

- The value of $R_{\theta JA}$ is measured with the device mounted on 1in 2 FR-4 board with 2oz. Copper, in a still air environment with $T_A=25^\circ\text{C}$.
- The data tested by pulsed, pulse width $\leq 300\mu\text{s}$, duty cycle $\leq 2\%$
- The EAS data shows Max. rating. The test condition is $V_{DD}=-25V, V_{GS}=-10V, L=0.1\text{mH}$.
- The data is theoretically the same as I_D and I_{DM} , in real applications, should be limited by total power dissipation.

The products and product specifications contained herein are subject to change without notice to improve performance characteristics. Consult us, or our representatives before use, to confirm that the information in this datasheet is up to date

We assume no responsibility for any infringement of patents, patent rights, or other rights arising from the use of any information and circuitry in this datasheet.

TYPICAL CHARACTERISTICS

Output Characteristics

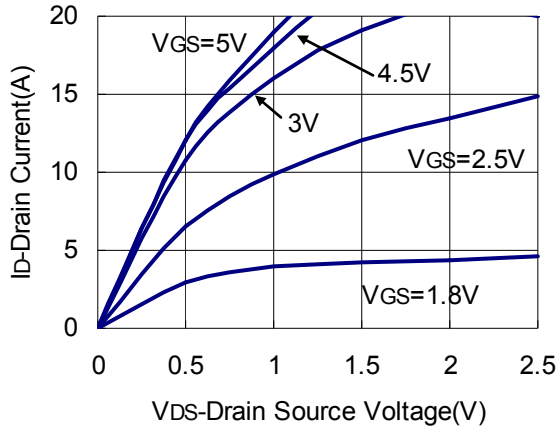

Drain-Source On Resistance

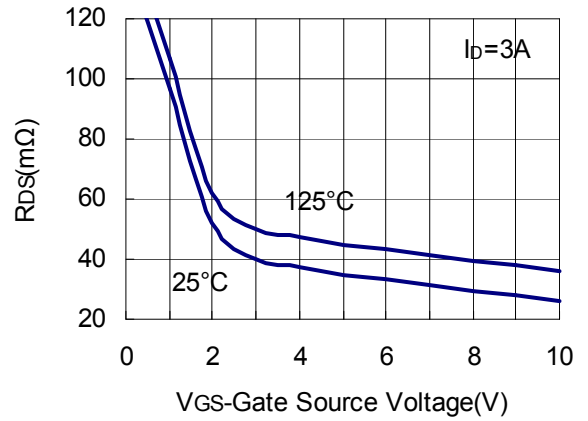

Drain Source On Resistance

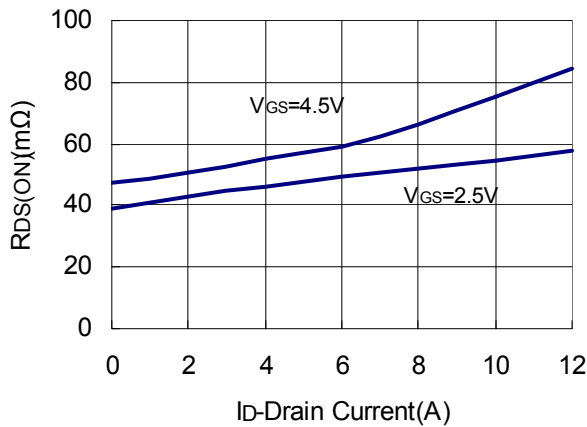

Gate Threshold Voltage

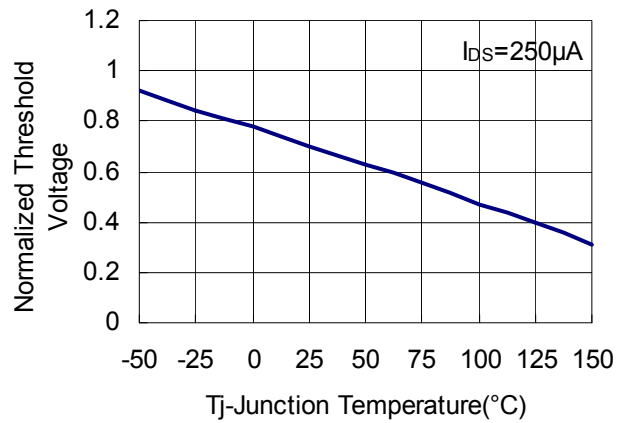

Gate Charge

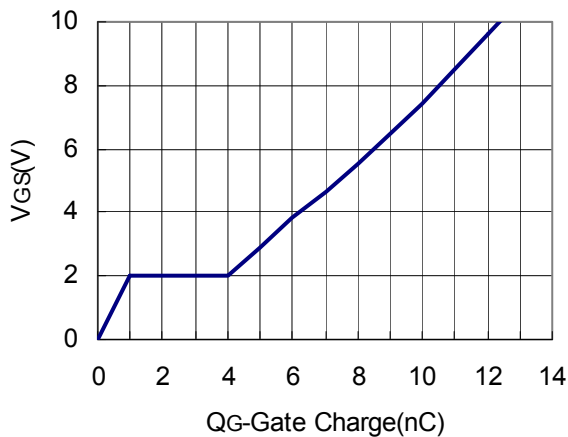

Gate Threshold Voltage

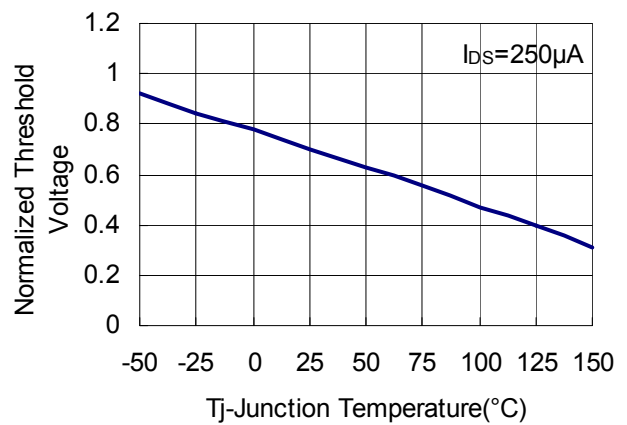

TYPICAL CHARACTERISTICS

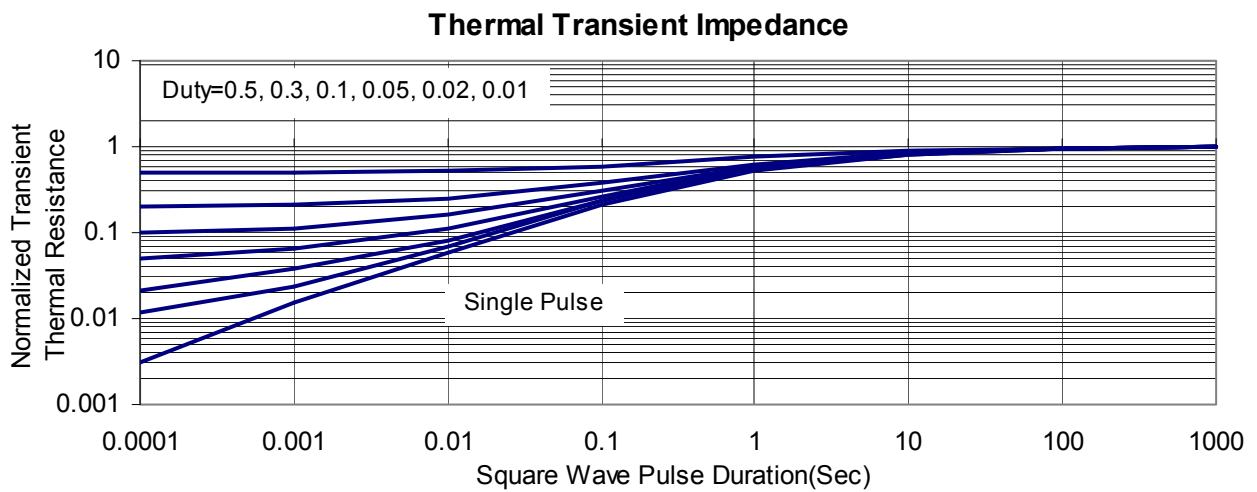
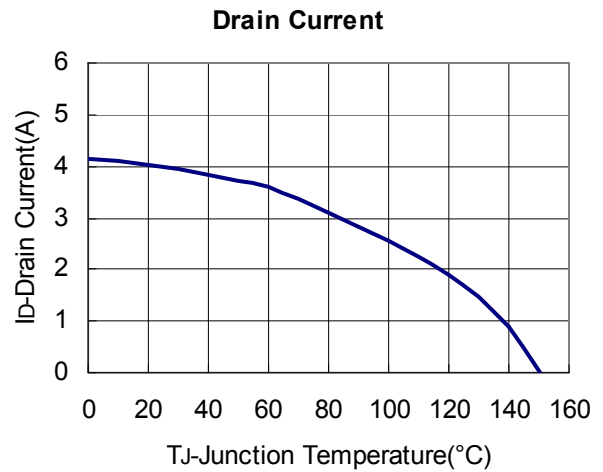
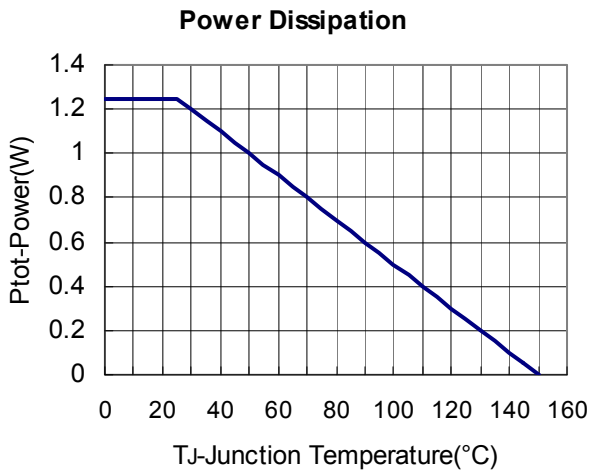
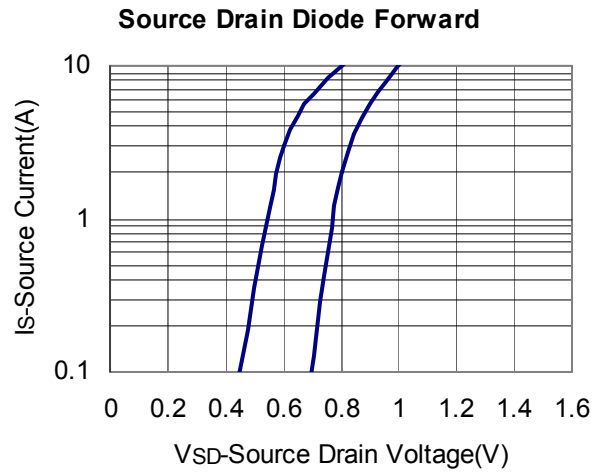
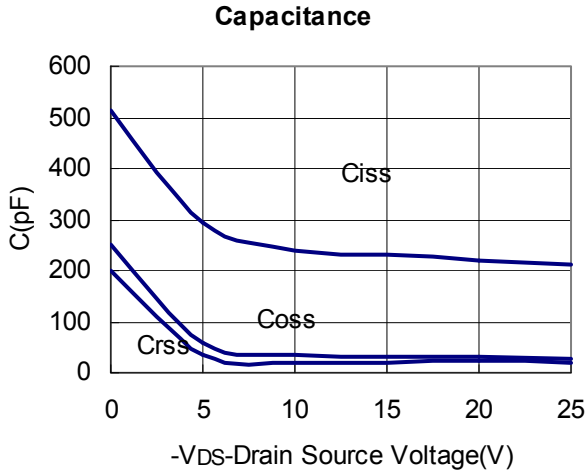

SOT-23 PACKAGE DIMENSIONS

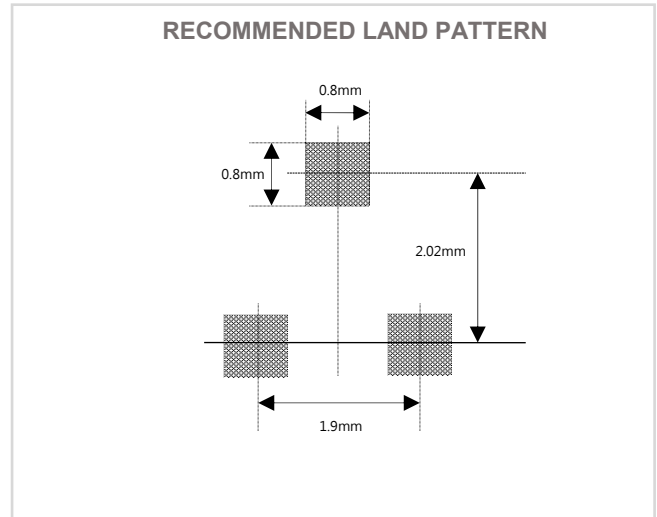
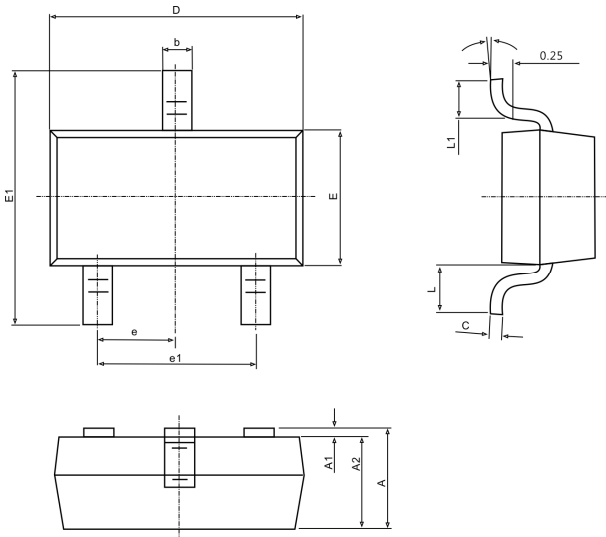

Symbol	Dimensions In Millimeters		Dimensions In Inches	
	Min.	Max.	Min.	Max.
A	0.900	1.150	0.035	0.045
A1	0.000	0.100	0.000	0.004
A2	0.900	1.050	0.035	0.041
b	0.300	0.500	0.012	0.020
c	0.080	0.150	0.003	0.006
D	2.800	3.000	0.110	0.118
E	1.200	1.400	0.047	0.055
E1	2.250	2.550	0.089	0.100
e	0.950 TYP.		0.037 TYP	
e1	1.800	2.000	0.071	0.079
L	0.550 REF.		0.022 REF.	
L1	0.300	0.500	0.012	0.020
θ	0°	8°	0°	8°