

DESCRIPTION

SMC6276LESN used trench technology are well suited for high efficiency fast switching applications, this MOSFET has been designed to minimize the on-state resistance and yet maintain superior switching performance, this devices are well suited for applications in the small surface mount package.

PART NUMBER INFORMATION

SMC 6276L E SN - TR G
 a b c d e f

- a : Company name.
- b : Product Serial number.
- c : ESD Protection
- d : Package code SN: SOT-23
- e : Handling code TR: Tape&Reel
- f : Green produce code G: RoHS Compliant

FEATURES

$V_{DS}=60V, I_D=0.45A$

$R_{DS(ON)}=1.6\Omega(Typ.)@V_{GS}=10V$
 $R_{DS(ON)}=2.0\Omega(Typ.)@V_{GS}=4.5V$

- ◆ Extremely Low Threshold Voltage
- ◆ Low Input Capacitance
- ◆ ESD Protection $>\pm 2KV$

APPLICATIONS

- ◆ Portable Appliances
- ◆ High speed switch
- ◆ Battery management

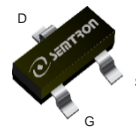

SOT-23

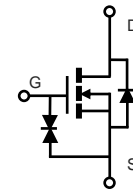

ABSOLUTE MAXIMUM RATINGS ($T_A=25^\circ C$ Unless otherwise noted)

Symbol	Parameter	Rating	Units
V_{DSS}	Drain-Source Voltage	60	V
V_{GSS}	Gate-Source Voltage	± 20	V
I_D	Continuous Drain Current	$T_A=25^\circ C$	0.45
		$T_A=70^\circ C$	0.36
I_{DM}	Pulsed Drain Current ^B	1.8	A
P_D	Power Dissipation ^A	$T_A=25^\circ C$	0.83
		$T_A=70^\circ C$	0.53
T_J	Operation Junction Temperature	-55/150	$^\circ C$
T_{STG}	Storage Temperature Range	-55/150	$^\circ C$

THERMAL RESISTANCE

Symbol	Parameter	Typ	Max	Units
$R_{\theta JA}$	Thermal Resistance Junction to Ambient ^A	$t \leq 10s$	150	$^\circ C/W$
	Thermal Resistance Junction to Ambient ^{AC}	Steady-State	300	$^\circ C/W$

ELECTRICAL CHARACTERISTICS ($T_A=25^\circ\text{C}$ Unless otherwise noted)

Symbol	Parameter	Condition	Min	Typ	Max	Unit
Static Parameters						
BV _{DSS}	Drain-Source Breakdown Voltage	V _{GS} =0V, I _D =250 μ A	60			V
V _{GS(th)}	Gate Threshold Voltage	V _{DS} =V _{GS} , I _D =250 μ A	0.7	1	1.2	V
I _{GSS}	Gate Leakage Current	V _{DS} =0V, V _{GS} = \pm 20V			\pm 10	μ A
I _{DSS}	Zero Gate Voltage Drain Current	V _{DS} =60V, V _{GS} =0V, T _J =25 $^\circ$ C			1	μ A
		V _{DS} =48V, V _{GS} =0V, T _J =85 $^\circ$ C			30	
R _{DS(ON)}	Drain-source On-Resistance ^D	V _{GS} =10V, I _D =0.45A		1.6	2.0	Ω
		V _{GS} =4.5V, I _D =0.3A		2.0	2.5	
		V _{GS} =2.5V, I _D =0.1A		4.0	5.5	
Diode Characteristics						
V _{SD}	Diode Forward Voltage ^D	I _S =0.2A, V _{GS} =0V			1.3	V
I _S	Diode Continuous Forward Current				0.23	A
Dynamic and Switching Parameters ^E						
Q _g	Total Gate Charge	V _{DS} =30V, V _{GS} =10V I _D =0.4A		1.28		nC
Q _{gs}	Gate-Source Charge			0.22		
Q _{gd}	Gate-Drain Charge			0.1		
C _{iss}	Input Capacitance	V _{DS} =30V, V _{GS} =0V, f=1MHz		28		pF
C _{oss}	Output Capacitance			7.6		
C _{rss}	Reverse Transfer Capacitance			6.4		
t _{d(on)}	Turn-On Time	V _{DD} =30V, V _{GS} =10V, R _G =3.9 Ω , I _D =0.4		3.3	6.3	nS
t _r				3.9	7.4	
t _{d(off)}	Turn-Off Time			8.8	16.7	
t _f				12	22.8	

Note: Absolute maximum ratings are those values beyond which the device could be permanently damaged.

- A. Surface mounted on FR4 board using 1 in² pad size.
- B. Pulsed width limited by maximum junction temperature, T_{J(MAX)}=150 $^\circ$ C.
- C. Using \leq 10s junction-to-ambient thermal resistance is base on T_{J(MAX)}=150 $^\circ$ C.
- D. Pulse test width \leq 300 μ s and duty cycle \leq 2%.
- E. Guaranteed by design, not subject to production testing.

The products and product specifications contained herein are subject to change without notice to improve performance characteristics. Consult us, or our representatives before use, to confirm that the information in this datasheet is up to date. We assume no responsibility for any infringement of patents, patent rights, or other rights arising from the use of any information and circuitry in this datasheet.

TYPICAL CHARACTERISTICS

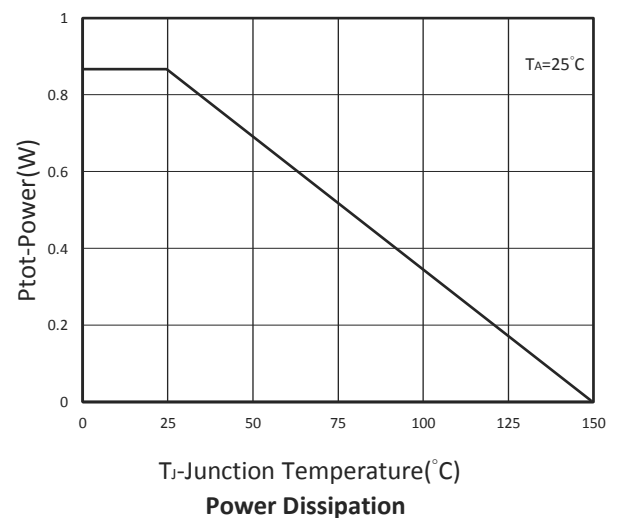
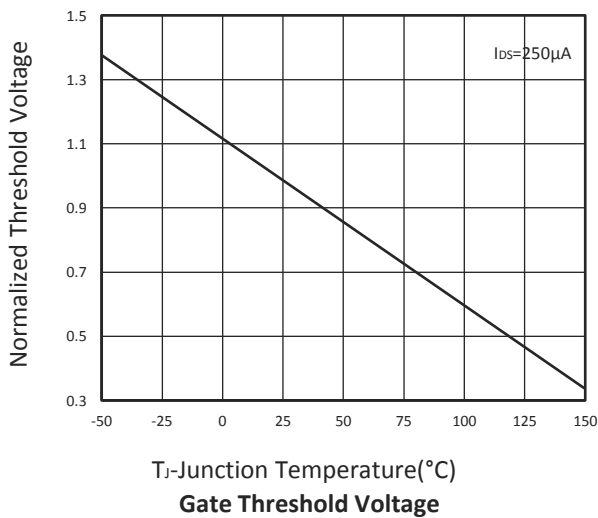
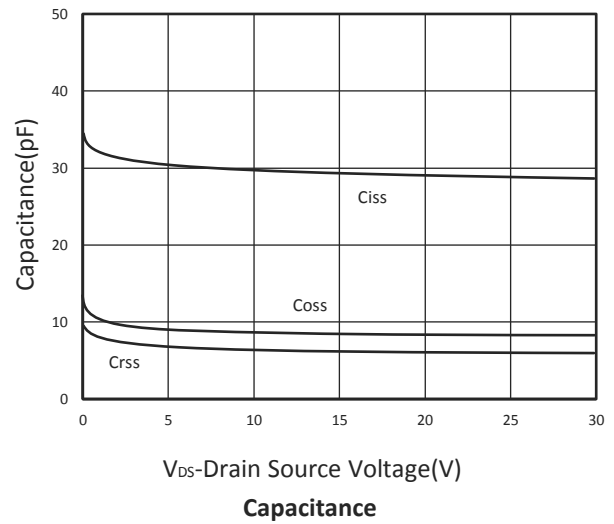
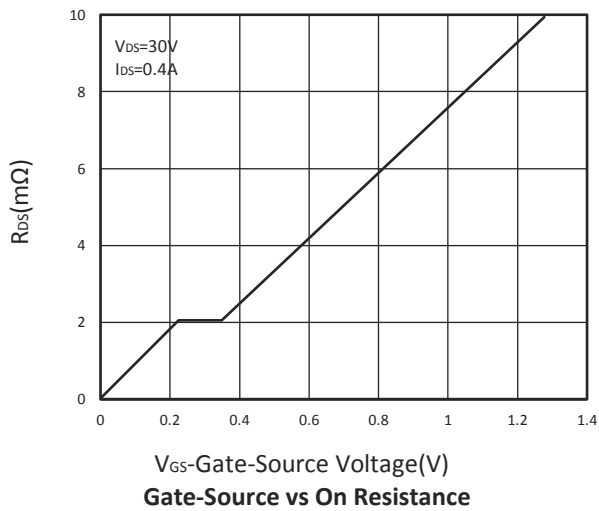
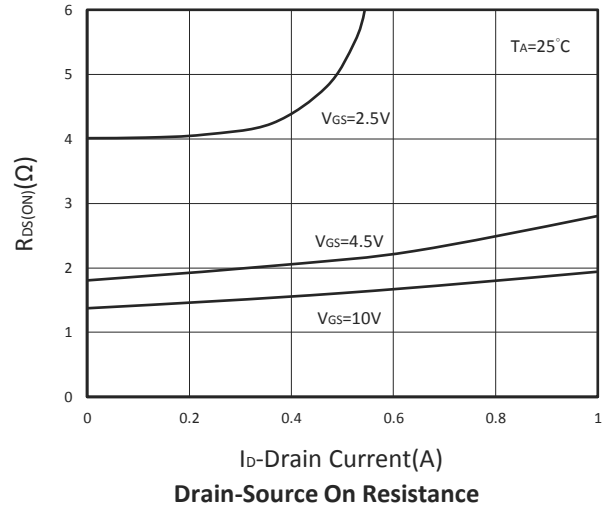
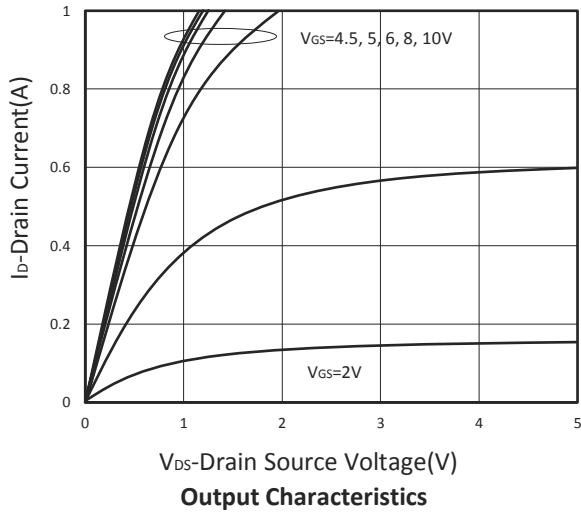

TYPICAL CHARACTERISTICS

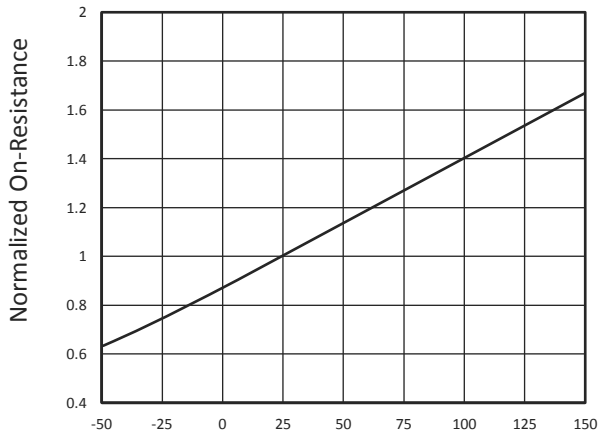

T_J-Junction Temperature(°C)
Drain-Source On Resistance

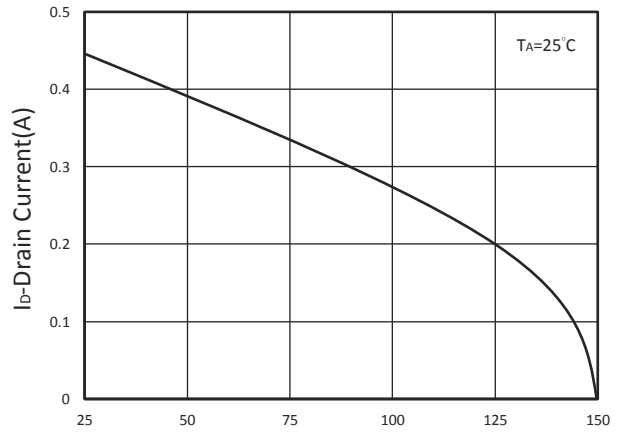

T_J-Junction Temperature(°C)
Drain Current vs T_J

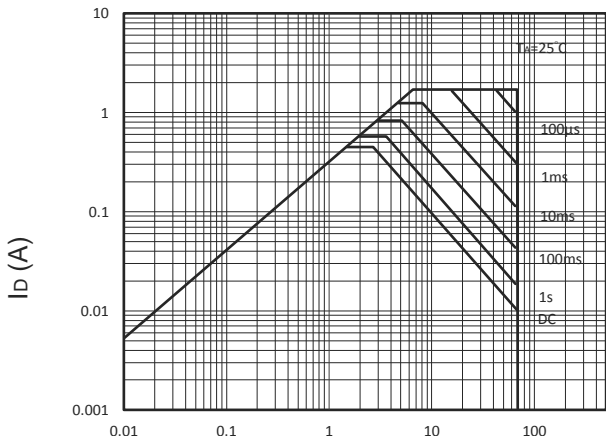

V_{DS} Voltage (V)
Maximum Safe Operation Area

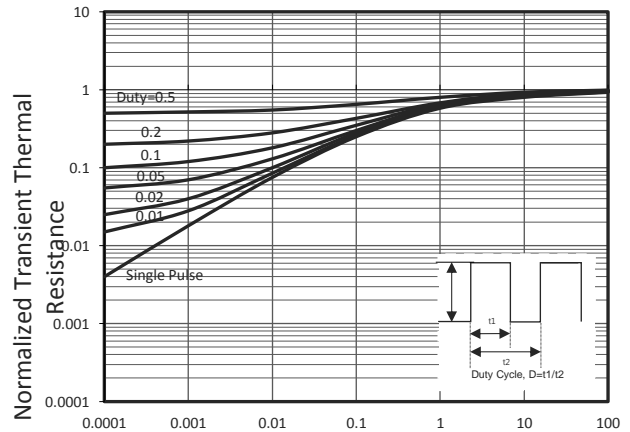

Square Wave Pulse Duration(Sec)
Thermal Transient Impedance

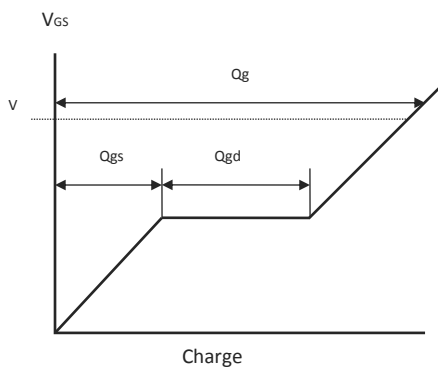

Gate Charge Waveform

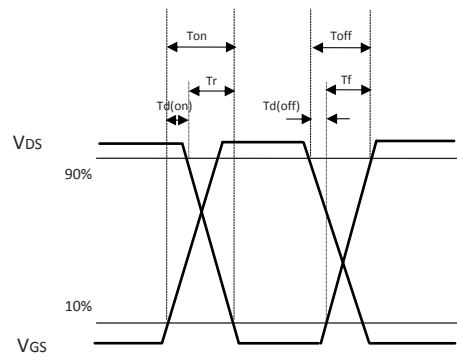

Switching Time Waveform

■ SOT-23 PACKAGE DIMENSIONS

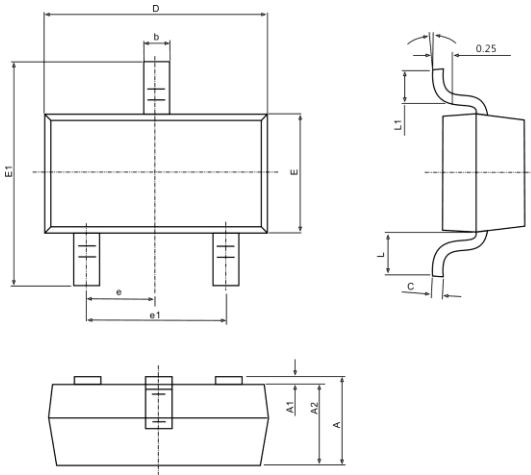

Recommended Land Pattern

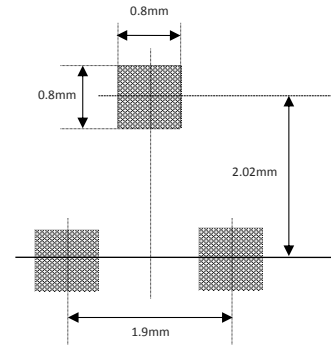

1.

Symbol	Dimensions In Millimeters		Dimensions In Inches	
	Min.	Max.	Min.	Max.
A	0.900	1.150	0.035	0.045
A1	0.000	0.100	0.000	0.004
A2	0.900	1.050	0.035	0.041
b	0.300	0.500	0.012	0.020
c	0.080	0.150	0.003	0.006
D	2.800	3.000	0.110	0.118
E	1.200	1.400	0.047	0.055
E1	2.250	2.550	0.089	0.100
e	0.950 BSC.		0.037 BSC	
e1	1.800	2.000	0.071	0.079
L	0.550 BSC		0.022 BSC	
L1	0.300	0.500	0.012	0.020
θ	0°	8°	0°	8°