

## Single P-Channel MOSFET

### DESCRIPTION

SMC3407 is the P-Channel enhancement mode power field effect transistors are using trench DMOS technology. This advanced trench technology devices are well suited for high efficiency fast switching applications, low in-line power loss needed in small outline surface mount package.

### PART NUMBER INFORMATION

**SMC 3407 S - TR G**  
 a      b      c      d      e

- a : Company name.
- b : Product Serial number.
- c : Package code            S: SOT-23L
- d : Handling code          TR: Tape&Reel
- e : Green produce code    G: *RoHS Compliant*

### FEATURES

**$V_{DS} = -30V$ ,  $I_D = -4.5A$**

$R_{DS(ON)}=43m\Omega(Typ.)@V_{GS}=-10V$   
 $R_{DS(ON)}=56m\Omega(Typ.)@V_{GS}=-4.5V$

- ◆ Fast switch

### APPLICATIONS

- ◆ Portable Equipment
- ◆ Power Management
- ◆ Load Switch

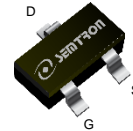

SOT-23L

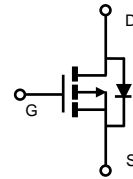

### ABSOLUTE MAXIMUM RATINGS ( $T_A = 25^\circ C$ Unless otherwise noted)

| Symbol    | Parameter                         | Rating           | Units      |
|-----------|-----------------------------------|------------------|------------|
| $V_{DSS}$ | Drain-Source Voltage              | -30              | V          |
| $V_{GSS}$ | Gate-Source Voltage               | $\pm 20$         | V          |
| $I_D$     | Continuous Drain Current          | $T_A=25^\circ C$ | -4.5       |
|           |                                   | $T_A=70^\circ C$ | -3.6       |
| $I_{DM}$  | Pulsed Drain Current <sup>A</sup> | -18              | A          |
| $P_D$     | Power Dissipation <sup>C</sup>    | $T_A=25^\circ C$ | 1.6        |
|           |                                   | $T_A=70^\circ C$ | 1          |
| $T_J$     | Operation Junction Temperature    | -55/150          | $^\circ C$ |
| $T_{STG}$ | Storage Temperature Range         | -55/150          | $^\circ C$ |

### THERMAL RESISTANCE

| Symbol          | Parameter  | Typ          | Max | Units        |
|-----------------|--|--------------|-----|--------------|
| $R_{\theta JA}$ | Thermal Resistance Junction to Ambient <sup>B</sup>  | $t \leq 10s$ | 80  | $^\circ C/W$ |
|                 | Thermal Resistance Junction to Ambient <sup>BD</sup> | Steady-State | 120 |              |

## ELECTRICAL CHARACTERISTICS ( $T_A = 25^\circ\text{C}$ Unless otherwise noted)

| Symbol                                  | Parameter                       | Condition  | Min | Typ      | Max       | Unit       |
|---|---------------------------------|--|-----|----------|-----------|------------|
| <b>Static Parameters</b>                |                                 |  |     |          |           |            |
| BV <sub>DSS</sub>                       | Drain-Source Breakdown Voltage  | V <sub>GS</sub> =0V, I <sub>D</sub> =-250 $\mu$ A  | -30 |          |           | V          |
| V <sub>GS(th)</sub>                     | Gate Threshold Voltage          | V <sub>DS</sub> =V <sub>GS</sub> , I <sub>D</sub> =-250 $\mu$ A                                      | -1  | -1.5     | -2.5      | V          |
| I <sub>GSS</sub>                        | Gate Leakage Current            | V <sub>DS</sub> =0V, V <sub>GS</sub> = $\pm$ 20V   |     |          | $\pm$ 100 | nA         |
| I <sub>DSS</sub>                        | Zero Gate Voltage Drain Current | V <sub>DS</sub> =-30V, V <sub>GS</sub> =0V, T <sub>J</sub> =25 $^\circ$ C                            |     |          | -1        | $\mu$ A    |
|   |                                 | V <sub>DS</sub> =-24V, V <sub>GS</sub> =0V, T <sub>J</sub> =75 $^\circ$ C                            |     |          | -10       |            |
| R <sub>DS(ON)</sub>                     | Drain-source On-Resistance      | V <sub>GS</sub> =-10V, I <sub>D</sub> =-4.5A<br>V <sub>GS</sub> =-4.5V, I <sub>D</sub> =-3.4A        |     | 43<br>56 | 48<br>66  | m $\Omega$ |
| G <sub>fs</sub>                         | Forward Transconductance        | V <sub>DS</sub> =-10V, I <sub>D</sub> =-4.5A   |     | 13       |           | S          |
| <b>Diode Characteristics</b>            |                                 |  |     |          |           |            |
| V <sub>SD</sub>                         | Diode Forward Voltage           | I <sub>S</sub> =-1A, V <sub>GS</sub> =0V   |     | -0.7     | -1        | V          |
| I <sub>S</sub>                          | Continuous Source Current       |  |     |          | -2.3      | A          |
| <b>Dynamic and Switching Parameters</b> |                                 |  |     |          |           |            |
| Q <sub>g</sub>                          | Total Gate Charge               | V <sub>DS</sub> =-15V, V <sub>GS</sub> =-10V,<br>I <sub>D</sub> =-4.5A                               |     | 15.8     | 22.1      | nC         |
| Q <sub>g</sub>                          | Total Gate Charge(4.5V)         |  |     | 7.7      | 10.8      |            |
| Q <sub>gs</sub>                         | Gate-Source Charge              |  |     | 2.3      | 3.2       |            |
| Q <sub>gd</sub>                         | Gate-Drain Charge               |  |     | 2.6      | 3.6       |            |
| C <sub>iss</sub>                        | Input Capacitance               | V <sub>DS</sub> =-15V, V <sub>GS</sub> =0V, f=1MHz   |     | 645      |           | pF         |
| C <sub>oss</sub>                        | Output Capacitance              |  |     | 63       |           |            |
| C <sub>rss</sub>                        | Reverse Transfer Capacitance    |  |     | 52       |           |            |
| t <sub>d(on)</sub>                      | Turn-On Time                    | V <sub>DD</sub> =-15V, V <sub>GEN</sub> =-10V,<br>R <sub>G</sub> =3.3 $\Omega$ , I <sub>D</sub> =-1A |     | 6        | 11        | nS         |
| t <sub>r</sub>                          |                                 |  |     | 12       | 23        |            |
| t <sub>d(off)</sub>                     | Turn-Off Time                   |  |     | 25.5     | 48        |            |
| t <sub>f</sub>                          |                                 |  |     | 7        | 13        |            |

Note: Absolute maximum ratings are those values beyond which the device could be permanently damaged.

- Pulsed width limited by maximum junction temperature, T<sub>J(MAX)</sub>=150 $^\circ$ C.
- The value is measured with the device mounted on 1in2 FR-4 board in a still air environment T<sub>A</sub> =25 $^\circ$ C with.
- The T<sub>J(MAX)</sub>=150 $^\circ$ C, using junction-to-ambient thermal resistance.
- T<sub>J(MAX)</sub>=150 $^\circ$ C, using junction-to-case thermal resistance (R<sub>θJC</sub>) is more useful in additional heat sinking is used.

The products and product specifications contained herein are subject to change without notice to improve performance characteristics. Consult us, or our representatives before use, to confirm that the information in this datasheet is up to date. We assume no responsibility for any infringement of patents, patent rights, or other rights arising from the use of any information and circuitry in this datasheet.

## TYPICAL CHARACTERISTICS

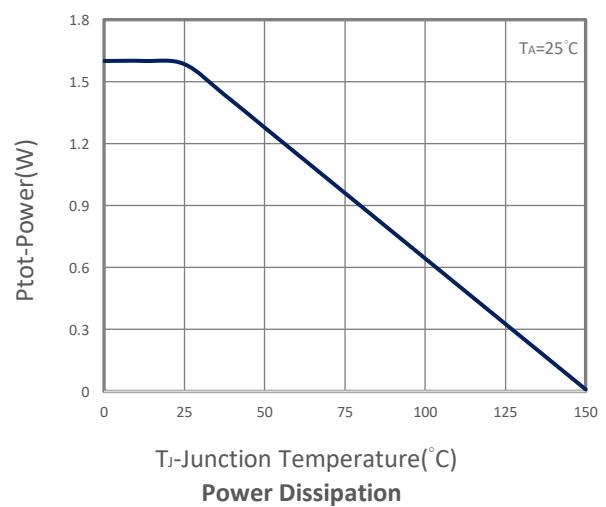
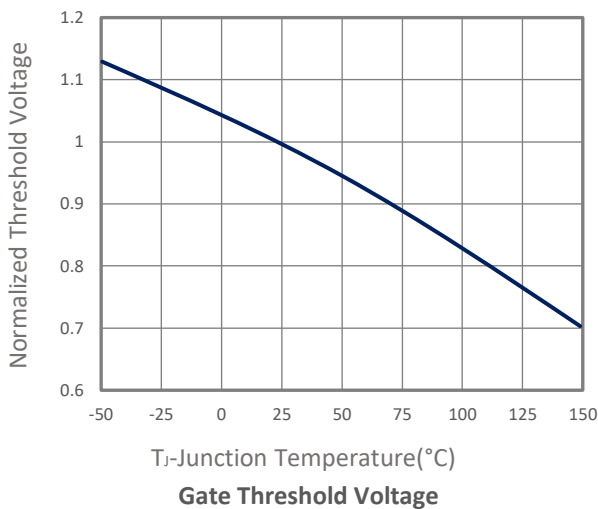
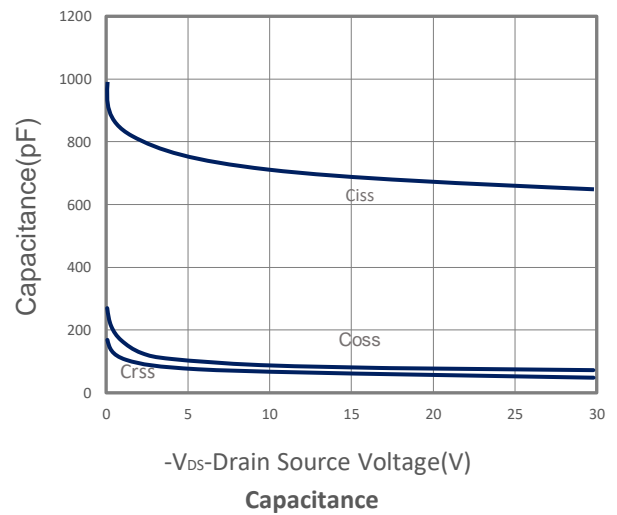
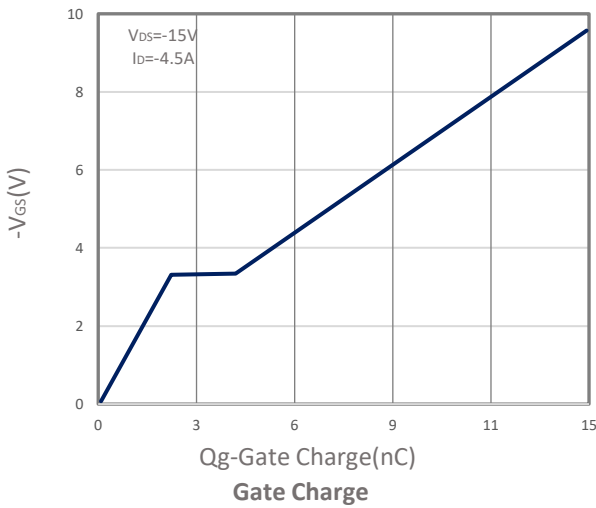
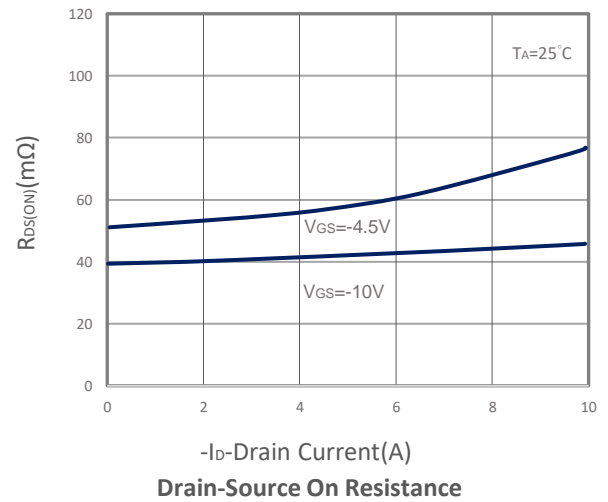
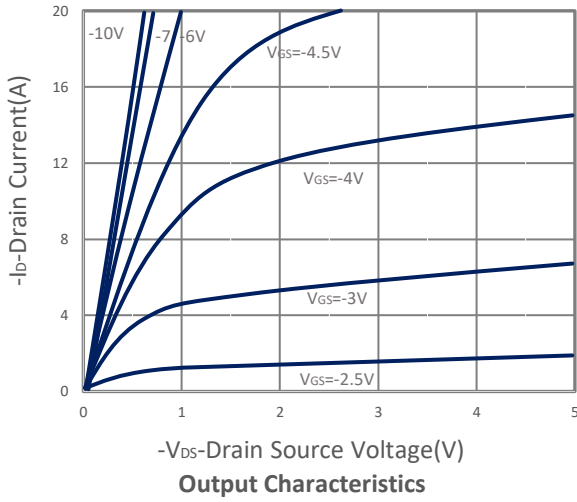

## TYPICAL CHARACTERISTICS

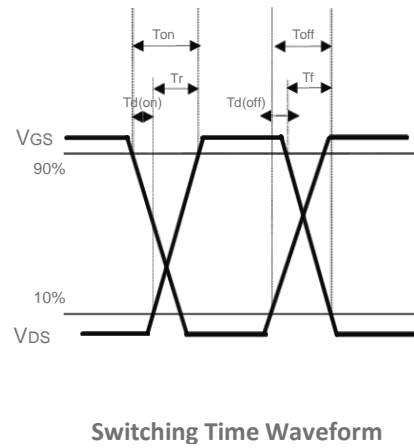
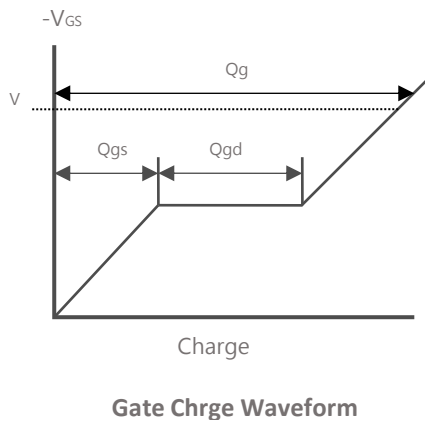
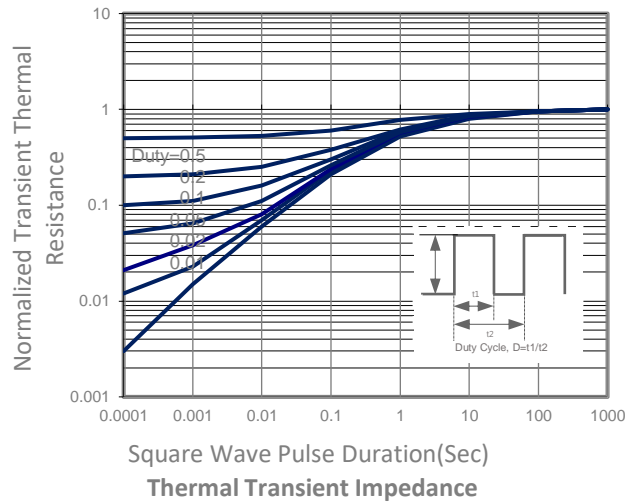
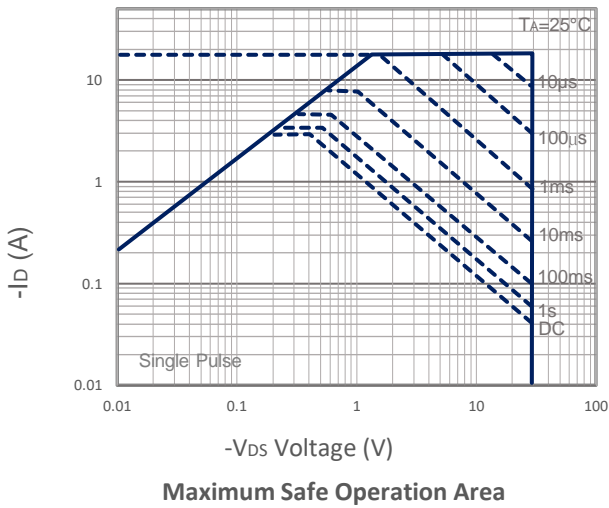
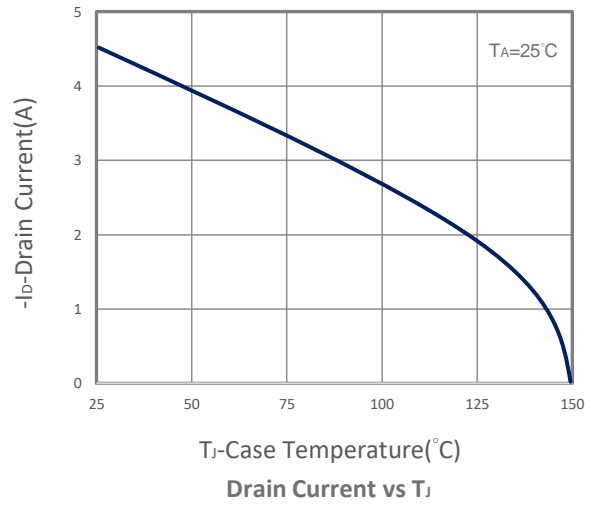
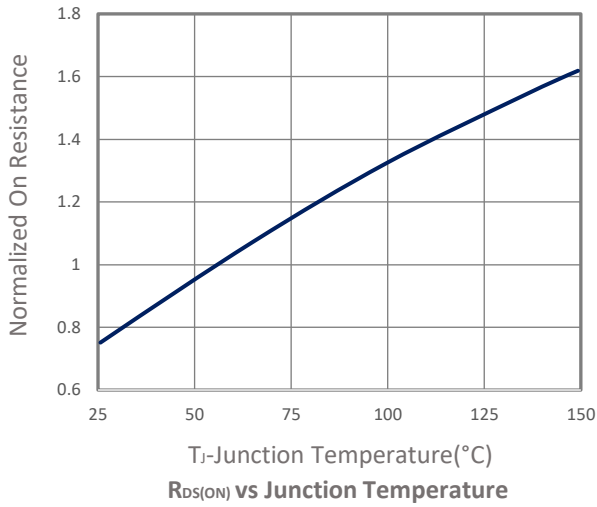

## ■ SOT-23L PACKAGE DIMENSIONS

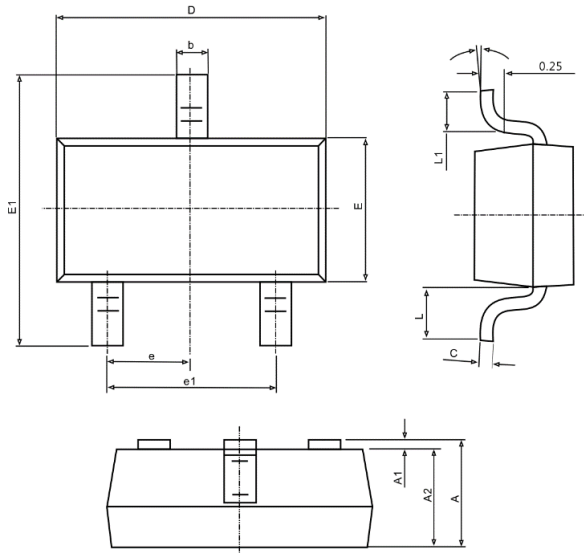

Recommended Minimum Pad(mm)

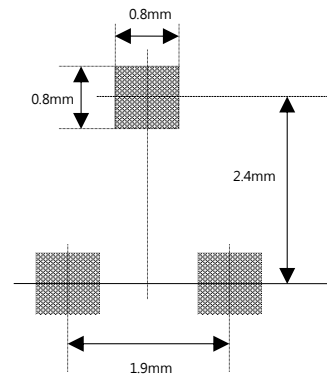

| Symbol | Dimensions In Millimeters |       | Dimensions In Inches |       |
|--------|---------------------------|-------|----------------------|-------|
|        | Min.                      | Max.  | Min.                 | Max.  |
| A      | 1.000                     | 1.300 | 0.039                | 0.049 |
| A1     | 0.000                     | 0.100 | 0.000                | 0.004 |
| A2     | 1.000                     | 1.200 | 0.039                | 0.047 |
| b      | 0.300                     | 0.500 | 0.012                | 0.020 |
| c      | 0.047                     | 0.207 | 0.002                | 0.008 |
| D      | 2.800                     | 3.000 | 0.110                | 0.118 |
| E      | 1.500                     | 1.700 | 0.059                | 0.067 |
| E1     | 2.600                     | 3.000 | 0.102                | 0.118 |
| e      | 0.950 TYP.                |       | 0.037 TYP.           |       |
| e1     | 1.900 TYP.                |       | 0.075 TYP.           |       |
| L1     | 0.250                     | 0.550 | 0.010                | 0.022 |
| θ      | 0°                        | 8°    | 0°                   | 8°    |