

## Single N-Channel MOSFET

### DESCRIPTION

SMC3332 is the N-Channel enhancement mode power field effect transistors are using trench DMOS technology. This advanced trench technology devices are well suited for high efficiency fast switching applications, low in-line power loss are needed in small outline surface mount package.

### PART NUMBER INFORMATION

**SMC 3332 SN - TR G**  
 a      b      c      d      e

- a : Company name.
- b : Product Serial number.
- c : Package code      SN: SOT-23
- d : Handling code      TR: Tape&Reel
- e : Green produce code G: *RoHS Compliant*

### FEATURES

**$V_{DS} = 30V, I_D = 5.4A$**

$R_{DS(ON)}=22m\Omega(Typ.)@V_{GS}=10V$   
 $R_{DS(ON)}=26m\Omega(Typ.)@V_{GS}=4.5V$   
 $R_{DS(ON)}=38m\Omega(Typ.)@V_{GS}=2.5V$

- ◆ Fast switch
- ◆ 2.5V Low gate drive applications

### APPLICATIONS

- ◆ Hand-Held Instruments
- ◆ Load Switch
- ◆ LED Applications

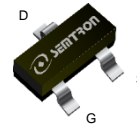

SOT-23

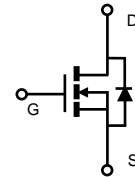

### ABSOLUTE MAXIMUM RATINGS ( $T_A = 25^\circ C$ Unless otherwise noted)

Symbol	Parameter	Rating	Units
$V_{DSS}$	Drain-Source Voltage	30	V
$V_{GSS}$	Gate-Source Voltage	$\pm 12$	V
$I_D$	Continuous Drain Current	$T_A=25^\circ C$	5.4
		$T_A=70^\circ C$	4.3
$I_{DM}$	Pulsed Drain Current <sup>A</sup>	22	A
$I_{AS}$	Avalanche Current <sup>A</sup>	8	A
$E_{AS}$	Single Pulse Avalanche energy $L=0.1mH$ <sup>AD</sup>	3.2	mJ
$P_D$	Power Dissipation <sup>B</sup>	$T_A=25^\circ C$	1.3
		$T_A=70^\circ C$	0.8
$T_J$	Operation Junction Temperature	-55/150	$^\circ C$
$T_{STG}$	Storage Temperature Range	-55/150	$^\circ C$

### THERMAL RESISTANCE

Symbol	Parameter	Typ	Max	Units
$R_{\theta JA}$	Thermal Resistance Junction to Ambient <sup>B</sup>	$t \leq 10s$	95	$^\circ C/W$
	Thermal Resistance Junction to Ambient <sup>BC</sup>	Steady-State	130	

## ELECTRICAL CHARACTERISTICS ( $T_A = 25^\circ\text{C}$ Unless otherwise noted)

Symbol	Parameter	Condition	Min	Typ	Max	Unit
<b>Static Parameters</b>						
BV <sub>DSS</sub>	Drain-Source Breakdown Voltage	V <sub>GS</sub> =0V, I <sub>D</sub> =250μA	30			V
V <sub>GS(th)</sub>	Gate Threshold Voltage	V <sub>DS</sub> =V <sub>GS</sub> , I <sub>D</sub> =250μA	0.5	0.7	1	V
I <sub>GSS</sub>	Gate Leakage Current	V <sub>DS</sub> =0V, V <sub>GS</sub> =±12V			±100	nA
I <sub>DSS</sub>	Zero Gate Voltage Drain Current	V <sub>DS</sub> =30V, V <sub>GS</sub> =0V, T <sub>J</sub> =25°C			1	μA
		V <sub>DS</sub> =24V, V <sub>GS</sub> =0V, T <sub>J</sub> =75°C			10	
R <sub>DS(ON)</sub>	Drain-source On-Resistance	V <sub>GS</sub> =10V, I <sub>D</sub> =5.4A		22	26	mΩ
		V <sub>GS</sub> =4.5V, I <sub>D</sub> =3.6A		26	32	
		V <sub>GS</sub> =2.5V, I <sub>D</sub> =2.5A		38	48	
G <sub>fs</sub>	Forward Transconductance	V <sub>DS</sub> =10V, I <sub>D</sub> =3A		7		S
<b>Diode Characteristics</b>						
V <sub>SD</sub>	Diode Forward Voltage	I <sub>S</sub> =1A, V <sub>GS</sub> =0V		0.75	1	V
I <sub>S</sub>	Continuous Source Current				2.7	A
<b>Dynamic and Switching Parameters</b>						
Q <sub>g</sub> (10V)	Total Gate Charge	V <sub>DS</sub> =15V, V <sub>GS</sub> =10V, I <sub>D</sub> =5A		13.5	18.9	nC
Q <sub>g</sub> (4.5V)	Total Gate Charge			6.6	8.9	
Q <sub>gs</sub>	Gate-Source Charge			1.5	3.5	
Q <sub>gd</sub>	Gate-Drain Charge			1.7	2.4	
C <sub>iss</sub>	Input Capacitance	V <sub>DS</sub> =15V, V <sub>GS</sub> =0V, f=1MHz		585		pF
C <sub>oss</sub>	Output Capacitance			42		
C <sub>rss</sub>	Reverse Transfer Capacitance			35		
t <sub>d(on)</sub>	Turn-On Time	V <sub>DD</sub> =15, V <sub>GEN</sub> =10V R <sub>G</sub> =6Ω, I <sub>D</sub> =1A		4.25	8.1	nS
t <sub>r</sub>				15.8	30	
t <sub>d(off)</sub>	Turn-Off Time			31	59	
t <sub>f</sub>				9.2	17	

Note: Absolute maximum ratings are those values beyond which the device could be permanently damaged.

- Pulsed width limited by maximum junction temperature, T<sub>J(MAX)</sub>=150°C.
- The value of R<sub>θJA</sub> is measured with the device mounted on 1in2 FR-4 board in a still air environment with maximum junction temperature T<sub>J(MAX)</sub>=150°C (initial temperature T<sub>A</sub>=25°C).
- T<sub>J(MAX)</sub>=150°C, using junction-to-case thermal resistance (R<sub>θJC</sub>) is more useful in additional heat sinking is used.
- The EAS data shows Max, tested and pulse width limited by T<sub>J(MAX)</sub>=150°C (initial temperature T<sub>J</sub>=25°C).

The products and product specifications contained herein are subject to change without notice to improve performance characteristics. Consult us, or our representatives before use, to confirm that the information in this datasheet is up to date. We assume no responsibility for any infringement of patents, patent rights, or other rights arising from the use of any information and circuitry in this datasheet.

**TYPICAL CHARACTERISTICS**

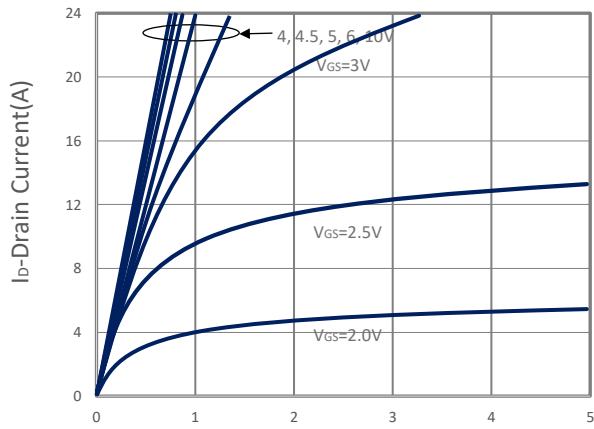

**Output Characteristics**

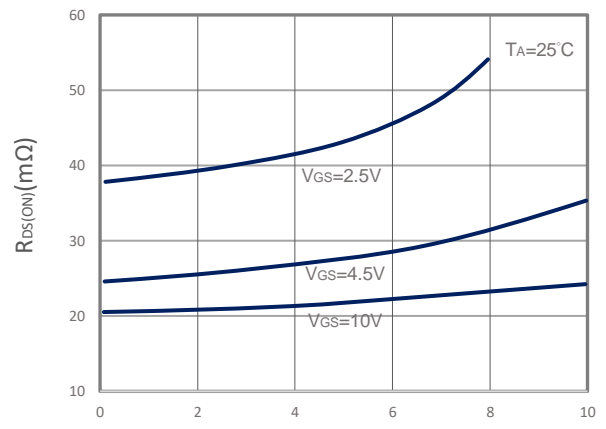

**Drain-Source On Resistance**

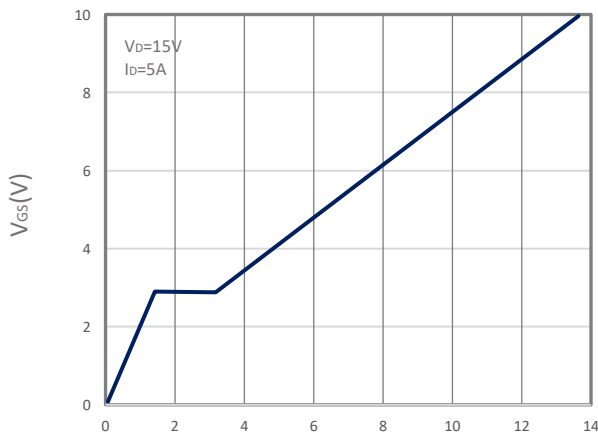

**Gate Charge**

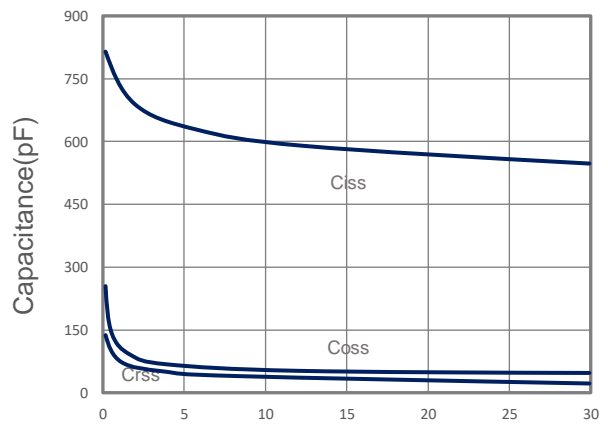

**Capacitance**

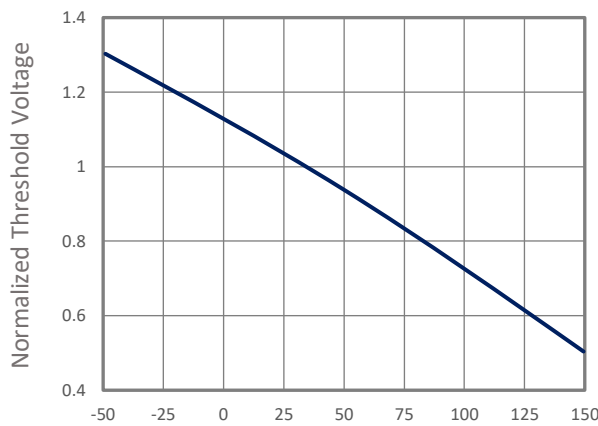

**Gate Threshold Voltage**

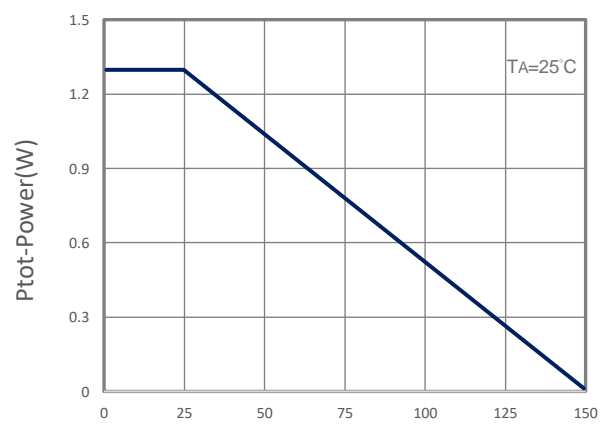

**Power Dissipation**

## TYPICAL CHARACTERISTICS

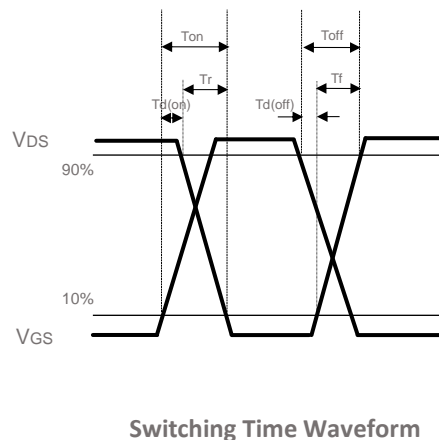
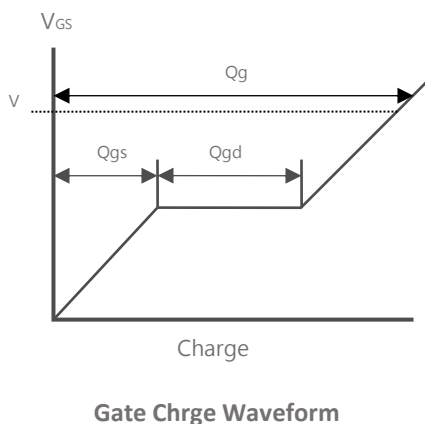
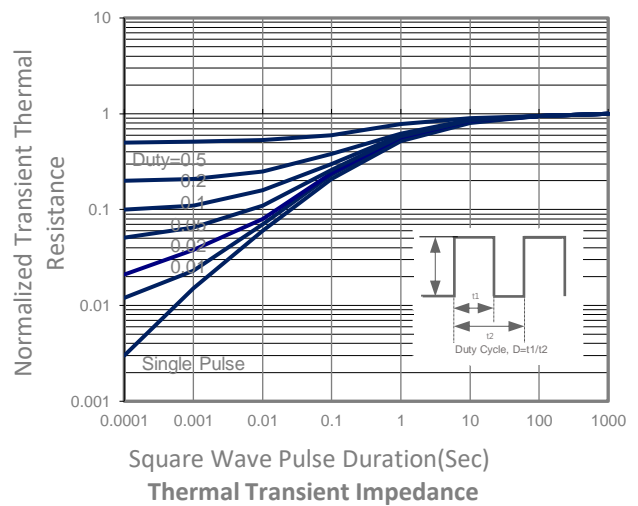
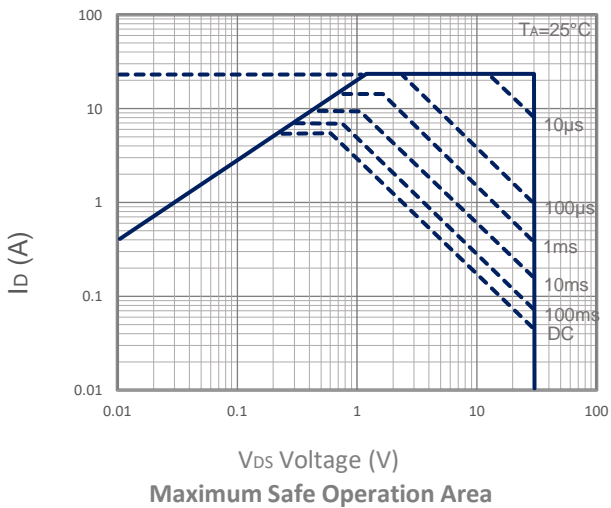
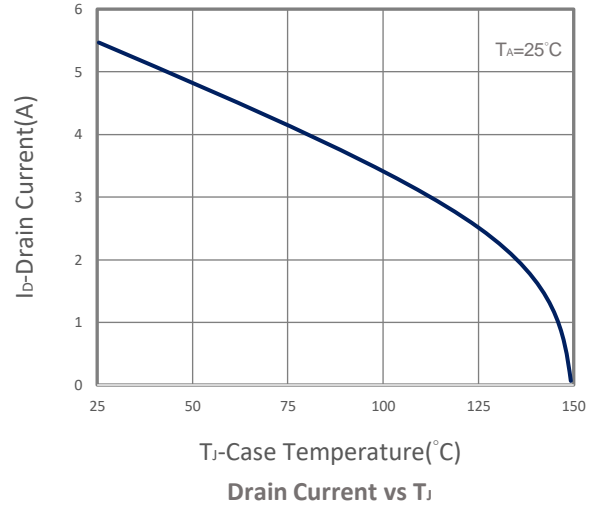
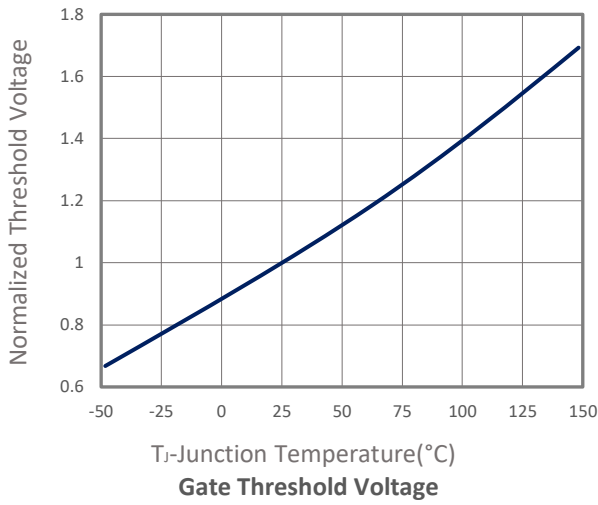

## SOT-23 PACKAGE DIMENSIONS

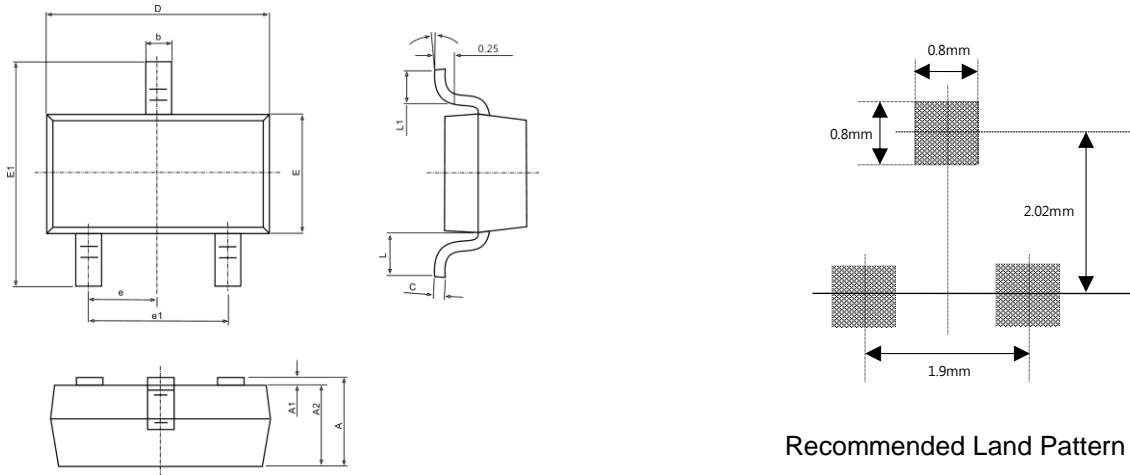

Symbol	Dimensions In Millimeters		Dimensions In Inches	
	Min.	Max.	Min.	Max.
A	0.900	1.150	0.035	0.045
A1	0.000	0.100	0.000	0.004
A2	0.900	1.050	0.035	0.041
b	0.300	0.500	0.012	0.020
c	0.080	0.150	0.003	0.006
D	2.800	3.000	0.110	0.118
E	1.200	1.400	0.047	0.055
E1	2.250	2.550	0.089	0.100
e	0.950 TYP.		0.037 TYP	
e1	1.800	2.000	0.071	0.079
L	0.550 REF.		0.022 REF.	
L1	0.300	0.500	0.012	0.020
$\theta$	0°	8°	0°	8°