

Single P-Channel MOSFET

DESCRIPTION

SMC2305 is the P-Channel enhancement mode power field effect transistors are using trench DMOS technology. This advanced trench technology devices are well suited for high efficiency fast switching applications, low in-line power loss are needed in small outline surface mount package.

PART NUMBER INFORMATION

SMC 2305 S - TR G
 a b c d e

- a : Company name.
- b : Product Serial number.
- c : Package code SN: SOT-23
- d : Handling code TR: Tape&Reel
- e : Green produce code G: *RoHS Compliant*

FEATURES

$V_{DS} = -20V$, $I_D = -4.2A$

- $R_{DS(ON)}=38m\Omega(Typ.)@V_{GS}=-10V$
- $R_{DS(ON)}=45m\Omega(Typ.)@V_{GS}=-4.5V$
- $R_{DS(ON)}=60m\Omega(Typ.)@V_{GS}=-2.5V$
- $R_{DS(ON)}=80m\Omega(Typ.)@V_{GS}=-1.8V$

- ◆ Fast switch
- ◆ 1.8V Low gate drive applications
- ◆ High power and current handling capability

APPLICATIONS

- ◆ Hand-Held Instruments
- ◆ Load Switch

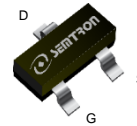

SOT-23

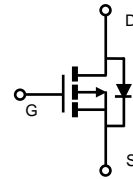

ABSOLUTE MAXIMUM RATINGS ($T_A = 25^\circ C$ Unless otherwise noted)

Symbol	Parameter	Rating	Units	
V_{DSS}	Drain-Source Voltage	-20	V	
V_{GSS}	Gate-Source Voltage	± 12	V	
I_D	Continuous Drain Current ($V_{GS}=4.5V$)	$T_A=25^\circ C$	-4.2	A
		$T_A=70^\circ C$	-3.3	A
I_{DM}	Pulsed Drain Current ^A	16.8	A	
P_D	Power Dissipation ^B	$T_A=25^\circ C$	1.4	W
		$T_A=70^\circ C$	0.9	W
T_J	Operation Junction Temperature	-55/150	$^\circ C$	
T_{STG}	Storage Temperature Range	-55/150	$^\circ C$	

THERMAL RESISTANCE

Symbol	Parameter	Typ	Max	Units
$R_{\theta JA}$	Thermal Resistance Junction to Ambient ^B	$t \leq 10s$	90	$^\circ C/W$
	Thermal Resistance Junction to Ambient ^{BC}	Steady-State	120	

ELECTRICAL CHARACTERISTICS ($T_A = 25^\circ\text{C}$ Unless otherwise noted)

Symbol	Parameter	Condition	Min	Typ	Max	Unit
Static Parameters						
BV _{DSS}	Drain-Source Breakdown Voltage	V _{GS} =0V, I _D =-250 μ A	-20			V
V _{GS(th)}	Gate Threshold Voltage	V _{DS} =V _{GS} , I _D =-250 μ A	-0.5	-0.7	-1	V
I _{GSS}	Gate Leakage Current	V _{DS} =0V, V _{GS} = \pm 12V			\pm 100	nA
I _{DSS}	Zero Gate Voltage Drain Current	V _{DS} =-20V, V _{GS} =0V, T _J =25 $^\circ$ C			-1	μ A
		V _{DS} =-16V, V _{GS} =0V, T _J =75 $^\circ$ C			-10	
R _{DS(ON)}	Drain-source On-Resistance	V _{GS} =-10V, I _D =-4.5A		38	43	m Ω
		V _{GS} =-4.5V, I _D =-4.2A		45	50	
		V _{GS} =-2.5V, I _D =-2.5A		60	68	
		V _{GS} =-1.8V, I _D =-2A		80	95	
G _{fs}	Forward Transconductance	V _{DS} =-10V, I _D =-3A		5.5		S
Diode Characteristics						
V _{SD}	Diode Forward Voltage ^B	I _S =-1A, V _{GS} =0V		-0.7	-1	V
I _S	Continuous Source Current				-2.1	A
Dynamic and Switching Parameters						
Q _g	Total Gate Charge	V _{DS} =-10V,, V _{GS} =-4.5V I _D =-4.2A		7.6	10.6	nC
Q _{gs}	Gate-Source Charge			1.62	2.3	
Q _{gd}	Gate-Drain Charge			1.2	1.7	
C _{iss}	Input Capacitance	V _{DS} =-10V, V _{GS} =0V, f=1MHz		680		pF
C _{oss}	Output Capacitance			76		
C _{rss}	Reverse Transfer Capacitance			45		
t _{d(on)}	Turn-On Time	V _{DD} =-10V, V _{GEN} =-4.5V, R _G =6 Ω , I _D =-1A		6	11	nS
t _r				8.7	17	
t _{d(off)}	Turn-Off Time			38	72	
t _f				11	21	

Note: Absolute maximum ratings are those values beyond which the device could be permanently damaged.

- A. Pulsed width limited by maximum junction temperature, T_{J(MAX)}=150 $^\circ$ C.
- B. The value of R θ _{JA} is measured with the device mounted on 1in2 FR-4 board in a still air environment with maximum junction temperature T_{J(MAX)}=150 $^\circ$ C (initial temperature T_A=25 $^\circ$ C).
- C. T_{J(MAX)}=150 $^\circ$ C, using junction-to-case thermal resistance (R θ _{JC}) is more useful in additional heat sinking is used.

The products and product specifications contained herein are subject to change without notice to improve performance characteristics. Consult us, or our representatives before use, to confirm that the information in this datasheet is up to date. We assume no responsibility for any infringement of patents, patent rights, or other rights arising from the use of any information and circuitry in this datasheet.

TYPICAL CHARACTERISTICS

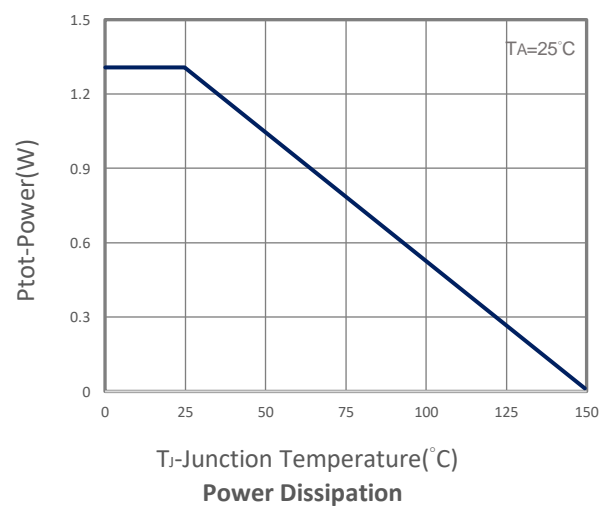
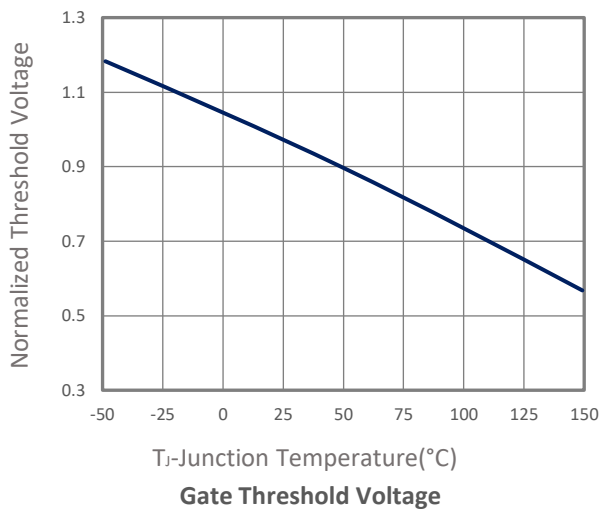
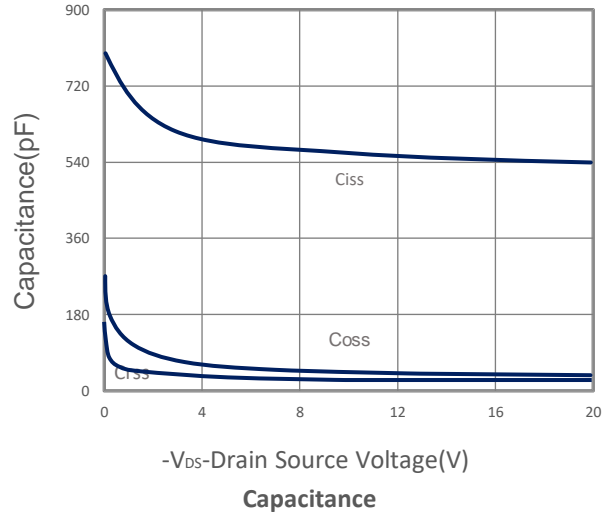
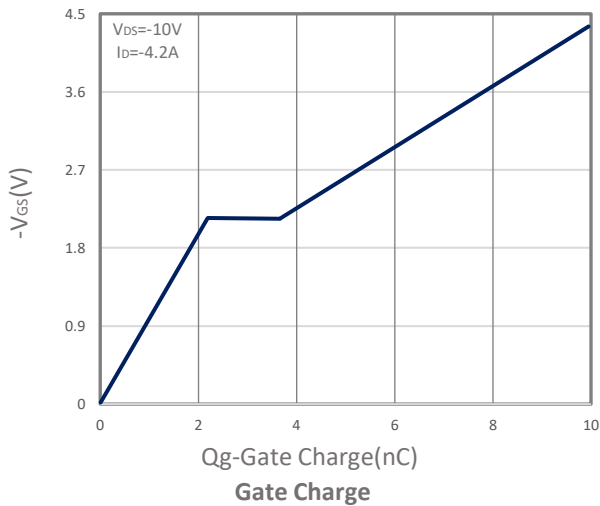
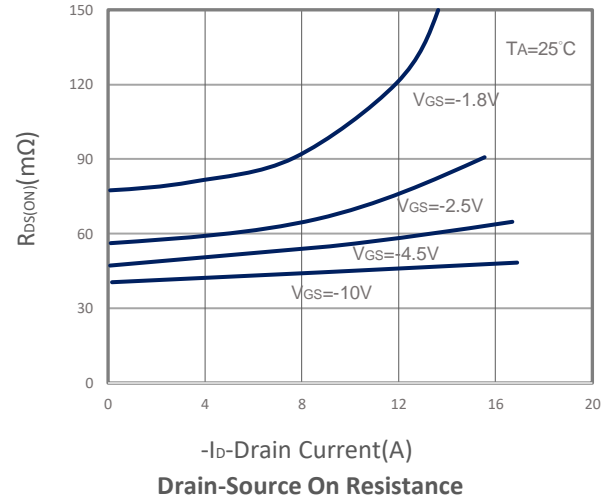
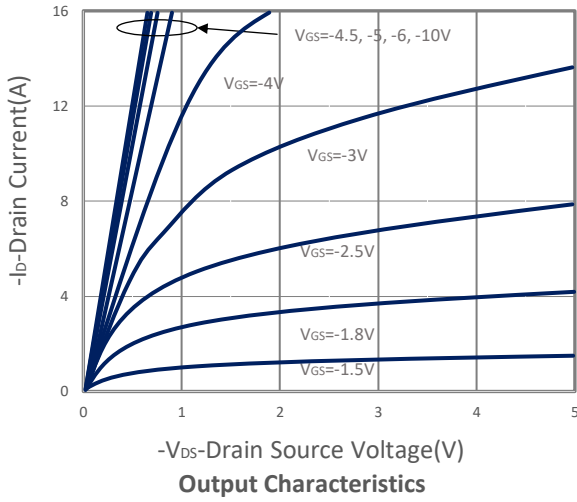

TYPICAL CHARACTERISTICS

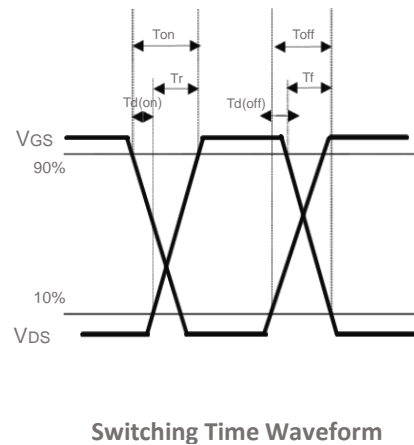
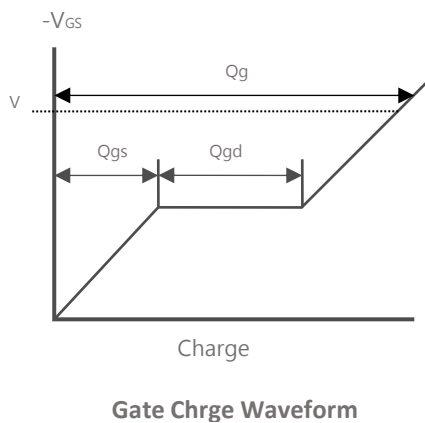
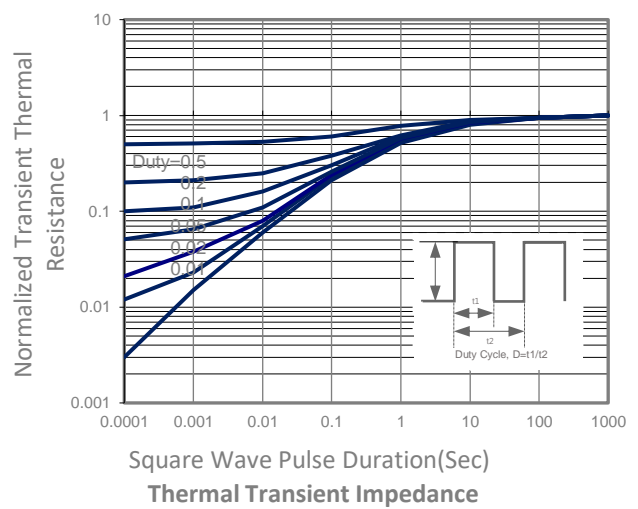
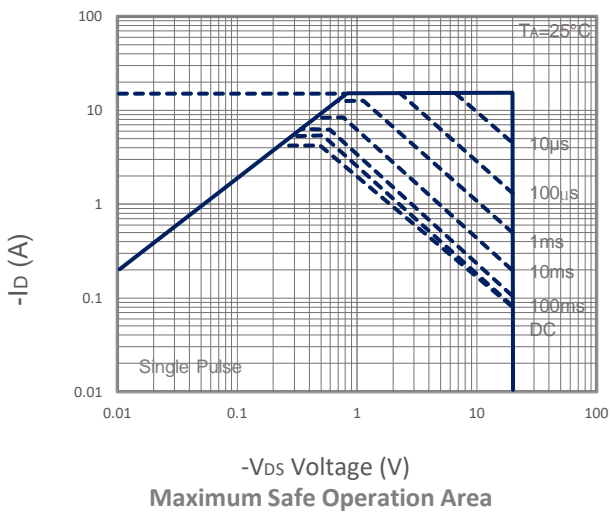
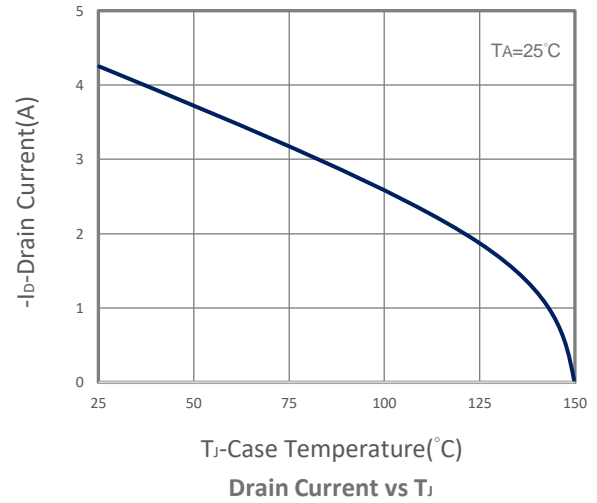
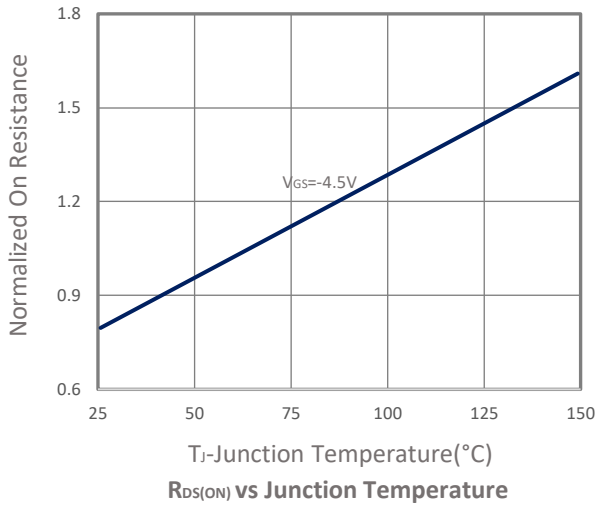

■ SOT-23 PACKAGE DIMENSIONS

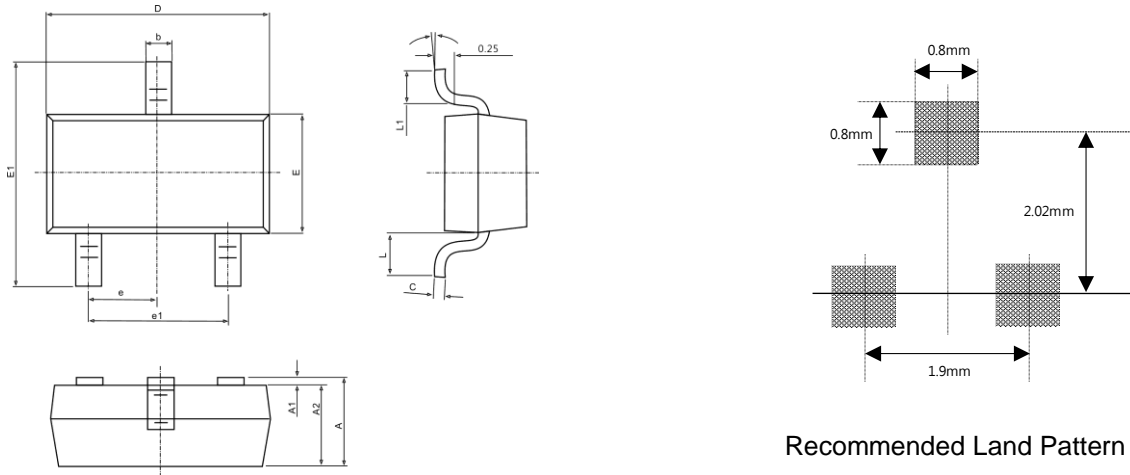

Symbol	Dimensions In Millimeters		Dimensions In Inches	
	Min.	Max.	Min.	Max.
A	0.900	1.150	0.035	0.045
A1	0.000	0.100	0.000	0.004
A2	0.900	1.050	0.035	0.041
b	0.300	0.500	0.012	0.020
c	0.080	0.150	0.003	0.006
D	2.800	3.000	0.110	0.118
E	1.200	1.400	0.047	0.055
E1	2.250	2.550	0.089	0.100
e	0.950 TYP.		0.037 TYP	
e1	1.800	2.000	0.071	0.079
L	0.550 REF.		0.022 REF.	
L1	0.300	0.500	0.012	0.020
θ	0°	8°	0°	8°