

500mA Low noise, High PSRR, Fast Transient Response LDO

DESCRIPTION

The STL6119 is a 500mA low noise and fast transient response linear regulator with adjustable output voltage and ultra-low dropout voltage. Its output voltage is programmed by a resistor divider, and can be as low as 0.8V, which satisfies the most advanced ICs which may require supply voltage to be 0.9V –1.2V. SMC6118 consists of a precise voltage reference, an error amplifier, a compensation network and a low ON-resistance power P-MOSFET. It also integrates many protection circuitry, like current limit and over-temperature protection module.

STL6119 ROHS Compliant This is Halogen Free

FEATURE

- ◆ Low Consumption Current: 40µA
- ◆ Shutdown Current <1µA
- ◆ Ultra Low Dropout Voltage: 370mV@500mA
- ◆ Thermal Overload Shutdown Protection
- ◆ Short-circuit Protection.
- ◆ High Ripple Rejection: 65dB
- ◆ Low ESR Capacitor Compatible

FEATURE

- ◆ Battery Powered Equipment.
- ◆ Portable Information Application
- ◆ PCMCIA & New Card
- ◆ Mini PCI & PCI-Express Cards
- ◆ Graphic Card
- ◆ Laptop, Palmtops, Notebook Computers

PIN CONFIGURATION

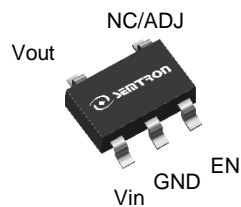

SOT-23 -5L
Top View

PART NUMBER INFORMATION

STL 6119 XX S5 – TR G
a b c d e f

a : Company name,Product Serial number.
b : Product Number
c : Output Voltage Code.
d : Package code.
e : Handling code.
f : Green produce code.

ORDERING INFORMATION

Part Number	Output Voltage	Package Code	Handling Code	Shipping
STL6119S5-TRG	ADJ	S5 : SOT-23-5L	TR : Tape&Reel	3K/Reel
STL6119-12S5-TRG	1.2V			
STL6119-18S5-TRG	1.8V			
STL6119-28S5-TRG	2.8V			
STL6119-30S5-TRG	3.0V			
STL6119-33S5-TRG	3.3V			

※ SOT-23-5L : Only available in tape and reel packaging.

ABSOLUTE MAXIMUM RATINGS (T_A = 25°C Unless otherwise noted)

Symbol	Parameter	Typical	Unit
V _{IN}	Input Voltage	-0.3 ~ +8V	V
V _{OUT}	EN, FB, SW Pin Voltage	V _{IN} -0.3 ~ V _{IN} +0.3	V
T _J	Operating Junction Temperature Range	-40 ~ +85	°C
T _{STG}	Storage Temperature Range	-65 ~ +150	°C
θ _{JA}	Thermal resistance junction to case(SOT-23-5L)	190	°C/W

Note: Exceeding these limits may damage the device. Exposure to absolute maximum rating conditions for long periods may affect device reliability.

Exceeding these ratings could cause damage to the device. All voltages are with respect to Ground. Currents are positive into, negative out of the specified terminal.

ELECTRICAL CHARACTERISTICS(T_J = 25°C Unless otherwise noted)

Operating conditions: V_{IN}=5V, T_A=25°C, unless otherwise noted

Symbol	Parameter	Condition	Min	Typ	Max	Unit
V _{IN}	Input Voltage		2.4		7.0	V
V _{OUT}	Output Voltage	For Fixed Output	-2%		+2%	V
V _{REF}	Feedback	ADJ Pin Reference Voltage	0.78	0.8	0.82	V
V _{LINE}	Line Regulation	2.5V < V _{IN} < 5.5V		0.075		%/V
V _{LOAD}	Load Regulation	0mA < I _{OUT} < 500mA	-	0.6		%/A
V _{DROP}	Dropout Voltage	I _{OUT} =100mA	-	75	-	mV
		I _{OUT} =300mA	-	225	-	
		I _{OUT} =500mA	-	375	-	
V _{IH}	EN Pin Input Voltage "H"		1.5	-	-	V
V _{IL}	EN Pin Input Voltage "L"		-	-	0.5	V
I _{CL}	Current Limit		-	1050	-	mA
I _{OUT}	Maximum Output Current (1)	V _{IN} -V _{OUT} =1V	-	900	1050	mA

Symbol	Parameter	Condition	Min	Typ	Max	Unit
I _Q	Quiescent Current	V _{FB} = 1V	-	40	-	μA
I _{SC}	Shutdown Current	V _{IN} =V _{OUT} +1V EN=0V, No Load	-	0.7	-	μA
I _{ADJ}	ADJ Pin Current	V _{IN} =V _{OUT} +1V I _{LOAD} =0 to 500mA	-	0.1	-	μA
I _{SHORT}	Short Circuit Current		-	-	200	mA
T _{DIS}	Discharge Time	V _{OUT} =0 to 3.3V, C _{OUT} =1μA (Fixed Type)		70	100	μS
T _{SD}	Thermal Shutdown Temperature		-	150	-	°C
T _{HYS}	Thermal Shutdown Hysteresis		-	20	-	°C
RA	Ripple Rejection Ratio	f=1KHz, I _{OUT} =30mA, C _{OUT} =1μF	-	65	-	dB

Note:

- (1) Measured using a double sided board with 1 x 2 square inches of copper area connected to the GND pin for "heat spreading".
- (2) The power dissipation values are based on the condition that temperature T_j and ambient temperature T_A difference is 100°C
- (3) Stresses beyond those listed under "absolute maximum rating" may cause permanent damage to the device. These are stress rating only, and function operation of the device at these or any other conditions beyond those indicated under "recommended operating conditions" is not implied. Exposure to absolute-maximum-rated conditions for extended periods may affect device reliability.

The products and product specifications contained herein are subject to change without notice to improve performance characteristics. Consult us, or our representatives before use, to confirm that the information in this datasheet is up to date.

FUNCTION BLOCK DIAGRAM

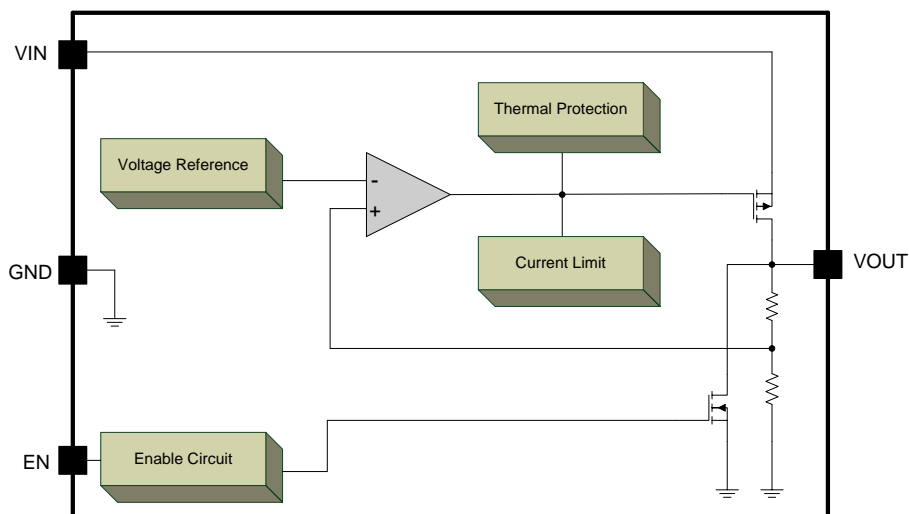

Fixed Type

FUNCTION BLOCK DIAGRAM

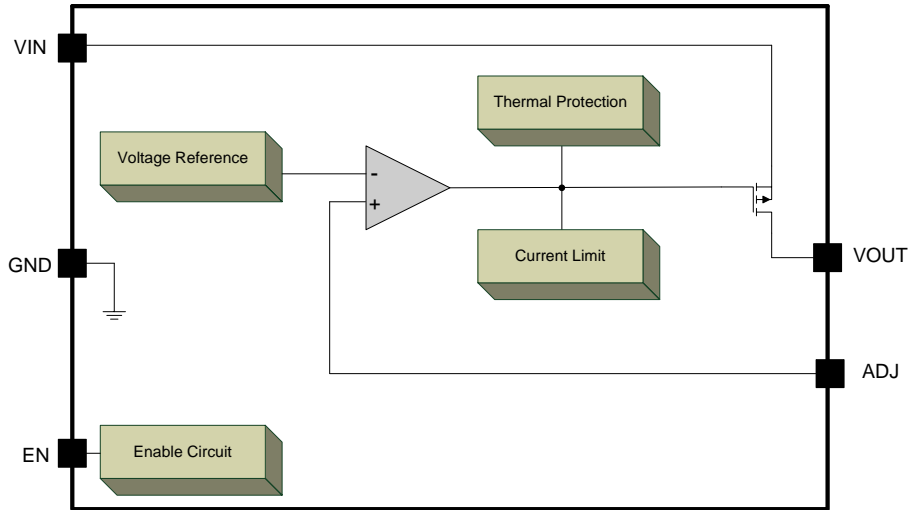

Adjustable Type

TYPICAL APPLICATIONS

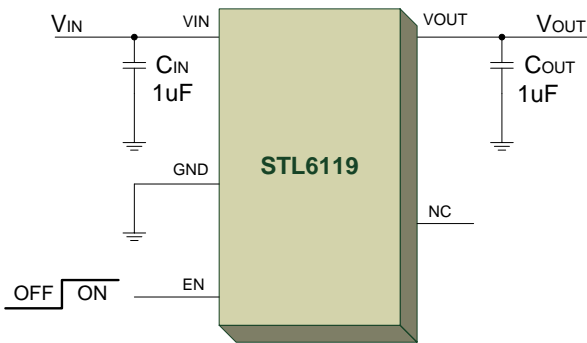

Fixed Type

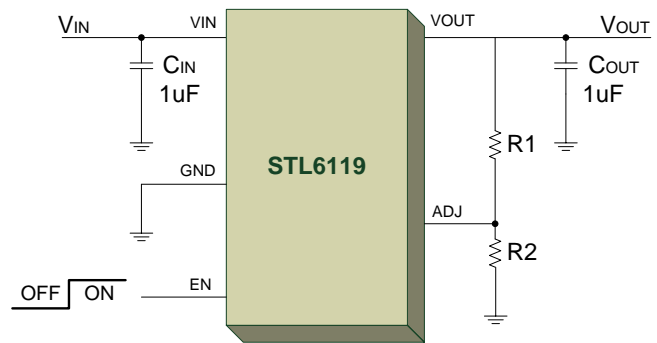

Adjustable Type

■ APPLICATION INFORMATION

◆ Detail Description

The STL6119 is a low-dropout linear regulator. The device provides preset 1.2V, 1.8V, 2.8V, 3.0V and 3.3V output voltages for output current up to 500mA. Adjustable output voltage and other mask options for special output voltages are also available, it consists of an error amplifier, a P-channel pass transistor and an internal feedback voltage divider.

The bandgap reference for fixed voltage types is connected to the error amplifier, which compares this reference with the feedback voltage and amplifies the voltage difference. If the feedback voltage is lower than the reference voltage, the pass-transistor gate is pulled lower, which allows more current to pass to the output pin and increases the output voltage. If the feedback voltage is too high, the pass transistor gate is pulled up to decrease the output voltage.

The output voltage is feed back through an internal resistive divider (or external resistive divider for adjustable output voltage type) connected to OUT pin. Additional blocks include an output current limiter, thermal sensor, and shutdown logic.

◆ Internal P-channel Pass Transistor

The STL6119 features a P-channel MOSFET pass transistor. Unlike similar designs using PNP pass transistors, P-channel MOSFETs require no base drive, which reduces quiescent current. PNP-based regulators also waste considerable current in dropout when the pass transistor saturates, and use high base-drive currents under large loads. The STL6119 does not suffer from these problems and consumes only 40μA (Typ.) of current consumption under heavy loads as well as in dropout conditions.

◆ Enable Function

EN pin starts and stops the regulator. When the EN pin is switched to the power off level, the operation of all internal circuit stops, the build-in P-channel MOSFET output transistor between pins V_{IN} and V_{OUT} is switched off, allowing current consumption to be drastically reduced. The V_{OUT} pin enters the GND level through the internal discharge path between V_{OUT} and GND pins.

◆ Fast Discharge Function

The STL6119 fixed type has fast discharge Function on EN pin disable. When user turns off the device, its internal pull-low resistor will discharge output capacitor charge. It'll avoid other device to arise wrong motions.

◆ Output Voltage Selection

For fixed voltage type of STL6119, the output voltage is preset at an internally trimmed voltage. The first two digits of part number suffix identify the output voltage (see Ordering Information). For example, the STL6119-33 has a preset 3.3V output voltage. For adjustable voltage type of STL6119, the output voltage is set by comparing the feedback voltage at adjust terminal to the internal bandgap reference voltage. The reference voltage V_{REF} is 0.8V. The output voltage is given by the equation:

$$V_{OUT} = V_{REF} \times (1 + R_1/R_2)$$

(See Typical Application Schematic.)

◆ Current Limit

The STL6119 also includes a fold back current limiter. It monitors and controls the pass transistor's gate voltage, estimates the output current, and limits the output current within 1.0A.

◆ Thermal Overload Protection

Thermal overload protection limits total power dissipation in the STL6119. When the junction temperature exceeds $T_J = +150^\circ\text{C}$, a thermal sensor turns off the pass transistor, allowing the IC to cool down. The thermal sensor turns the pass transistor on again after the junction temperature cools down by 20°C , resulting in a pulsed output during continuous thermal overload conditions.

Thermal overload protection is designed to protect the STL6119 in the event of fault conditions. For continuous operation, the absolute maximum operating junction temperature rating of $T_J = +125^\circ\text{C}$ should not be exceeded.

◆ Operating Region and Power Dissipation

Maximum power dissipation of the STL6119 depends on the thermal resistance of the case and circuit board, the temperature difference between

the die junction and ambient air, and the rate of airflow. The power dissipation across the devices is $P = I_{OUT} \times (V_{IN} - V_{OUT})$. The resulting maximum power

dissipation is:

$$P_{MAX} = (T_J - T_A) / (\theta_{JC} + \theta_{CA})$$

$$= (T_J - T_A) / \theta_{JA}$$

Where $(T_J - T_A)$ is the temperature difference between the STL6119 die junction and the surrounding air, θ_{JC} is the thermal resistance of the package chosen, and θ_{CA} is the thermal resistance through the printed circuit board, copper traces and other materials to the surrounding air. For better

heat-sinking, the copper area should be equally shared between the IN, OUT, and GND pins.

◆Dropout Voltage

A regulator's minimum input-output voltage differential, or dropout voltage, determines the lowest usable supply voltage. In battery-powered systems, this will determine the useful end-of-life battery voltage. The STL6119 use a P-channel MOSFET pass transistor, its dropout voltage is a function of drain-to-source on-resistance $R_{DS(ON)}$ multiplied by the load current.

$$V_{DROPOUT} = V_{IN} - V_{OUT} = R_{DS(ON)} \times I_{OUT}$$

■ TYPICAL OPERATING CHARACTERISTICS

Typical values are at $T_A = 25^\circ\text{C}$ unless otherwise noted

Dropout Voltage

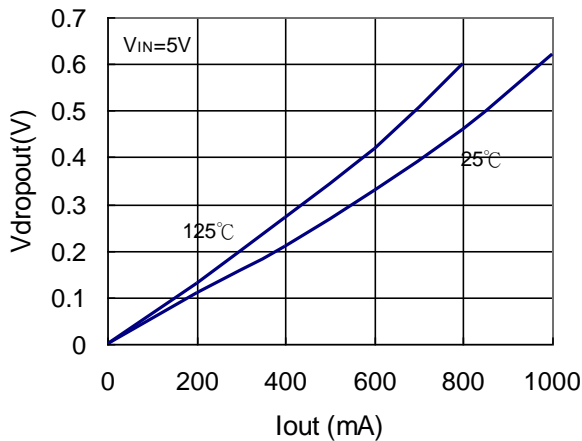

Dropout Voltage

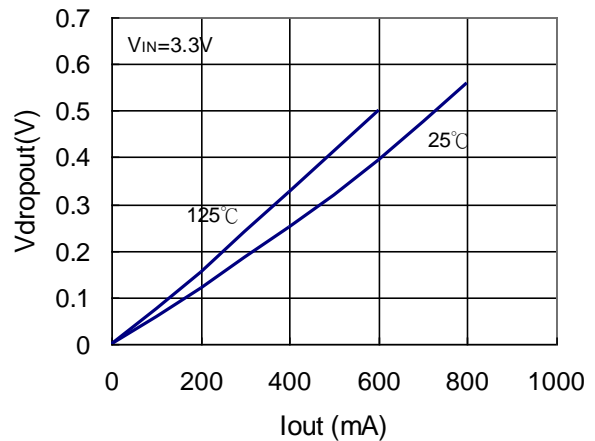

Dropout Voltage

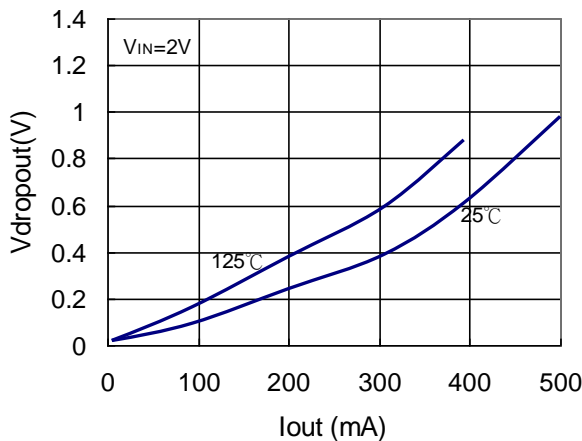

Quiescent current

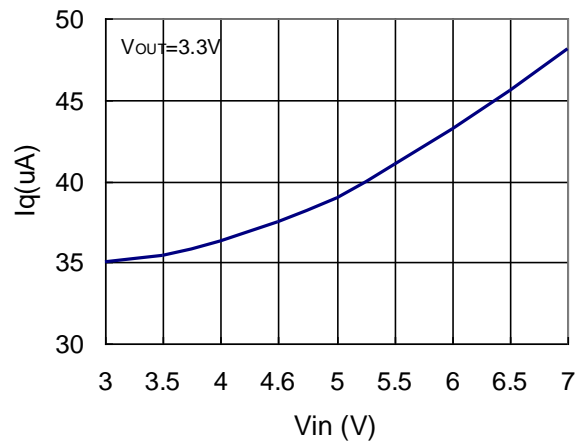

Line Regulation

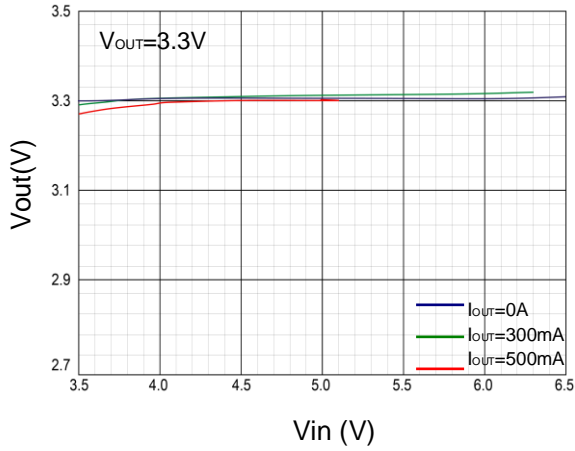

Load Regulation

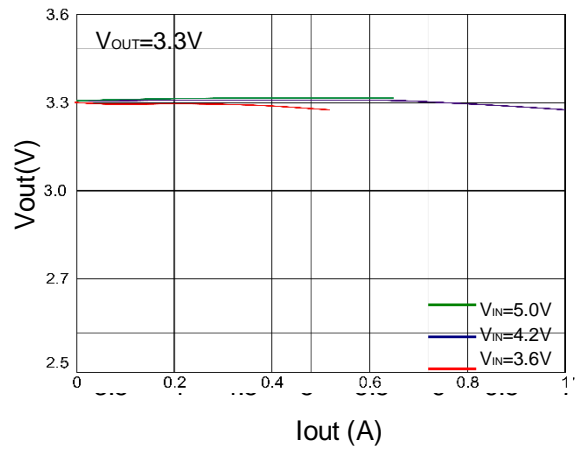

Line Regulation

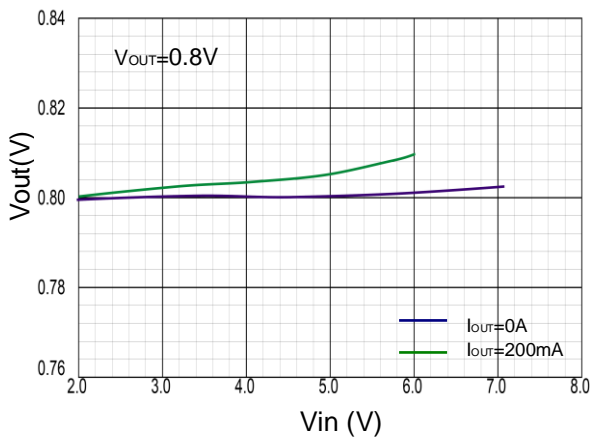

Load Regulation

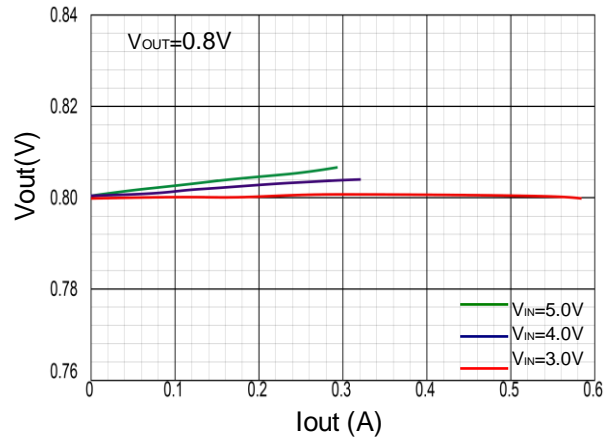

OPERATING WAVEFORMS

Typical values are at TA=25°C unless otherwise noted

Load Transient Response

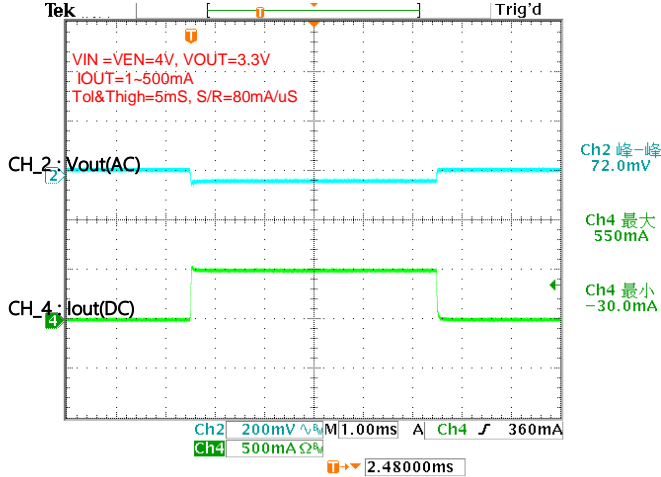

Start-up Waveform

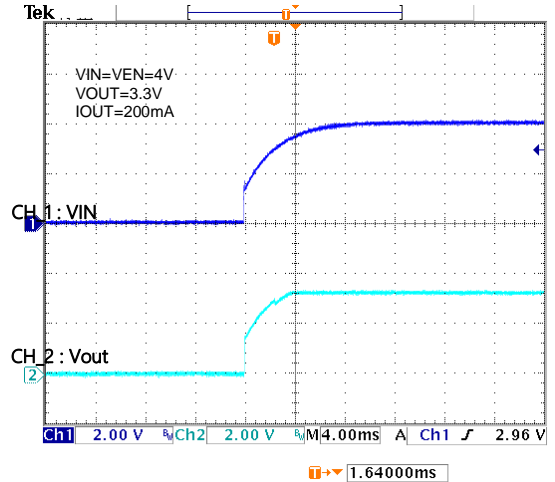

■ SOT-23-5L PACKAGE DIMENSIONS

Symbol	Dimensions In Millimeters		Dimensions In Inches	
	Min.	Max.	Min.	Max.
A	1.050	1.250	0.041	0.049
A1	0.000	0.100	0.000	0.004
A2	1.050	1.150	0.041	0.045
b	0.300	0.500	0.012	0.020
c	0.100	0.200	0.004	0.008
D	2.820	3.020	0.111	0.119
E	1.500	1.700	0.059	0.067
E1	2.650	2.950	0.104	0.116
e	0.950 BSC		0.037 BSC	
e1	1.800	2.000	0.710	0.790
L	0.300	0.600	0.012	0.024
θ	0°	8°	0°	8°

