

150KHz, 3A PWM Buck DC/DC Converter

DESCRIPTION

The SMC2596A series of regulators are monolithic integrated circuits that provide all the active functions for a step-down (buck) switching regulator, capable of driving 3A load with excellent line and load regulation. These devices are available in fixed output voltage of 3.3V and 5V an adjustable Coutput version.

The SMC2596A operates at a switching frequency of 150KHz thus allowing smaller sized filter components than what would be needed with lower frequency switching regulators.

Other features include a guaranteed $\pm 4\%$ tolerance on output voltage under specified input voltage and output load conditions, and $\pm 15\%$ on the oscillator frequency. External shutdown is included, featuring typically 70 μ A(Typ.) standby current.

SMC2596A-XXD-TRG ROHS Compliant This is Halogen Free

FEATURE

- ◆ 3.3V, 5V, and adjustable output versions
- ◆ Adjustable version output voltage range 1.23V to 37V
- ◆ Input voltage range up to 40V
- ◆ Guaranteed 3A output current
- ◆ 150KHz fixed frequency internal oscillator
- ◆ Built-in thermal shutdown and current limit protection
- ◆ TTL shutdown capability, low power standby mode
- ◆ Uses readfily available standard inductors

APPLICATIONS

- ◆ Positive to negative converter
- ◆ On-Card switching regulation
- ◆ Simple high efficiency Step-down regulator



PWM Control Step-Down DC/DC Converter

PIN CONFIGURATION

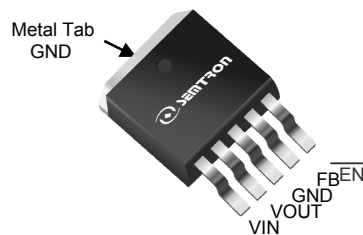

TO263-5L
Top View

PART NUMBER INFORMATION

<u>SMC</u> <u>2596A</u> - <u>XX</u> <u>D</u> <u>TR</u> <u>G</u> a b c d e f	<p>a : Company name. b : Product Serial number. c : Voltage Code. XX 33 : 3.3V, 50 : 5.0V, ADJ : ADJ</p> <p>d : Package code. e : Handling code. f : Green produce code.</p>
---	--

ORDERING INFORMATION

Part Number	Package Code	VOUT Voltage	Shipping
SMC2596A-XXD-TRG	D :TO-263-5L	3.3	800 Pcs/Reel
		5.0	
		ADJ	

- ※ Year Code : 0 ~ 9, 2011 : 1
- ※ Week Code : A(1~2) ~ Z(53~54)
- ※ TO-263-5L : Only available in tape and reel packaging.

BLOCK DIAGRAM

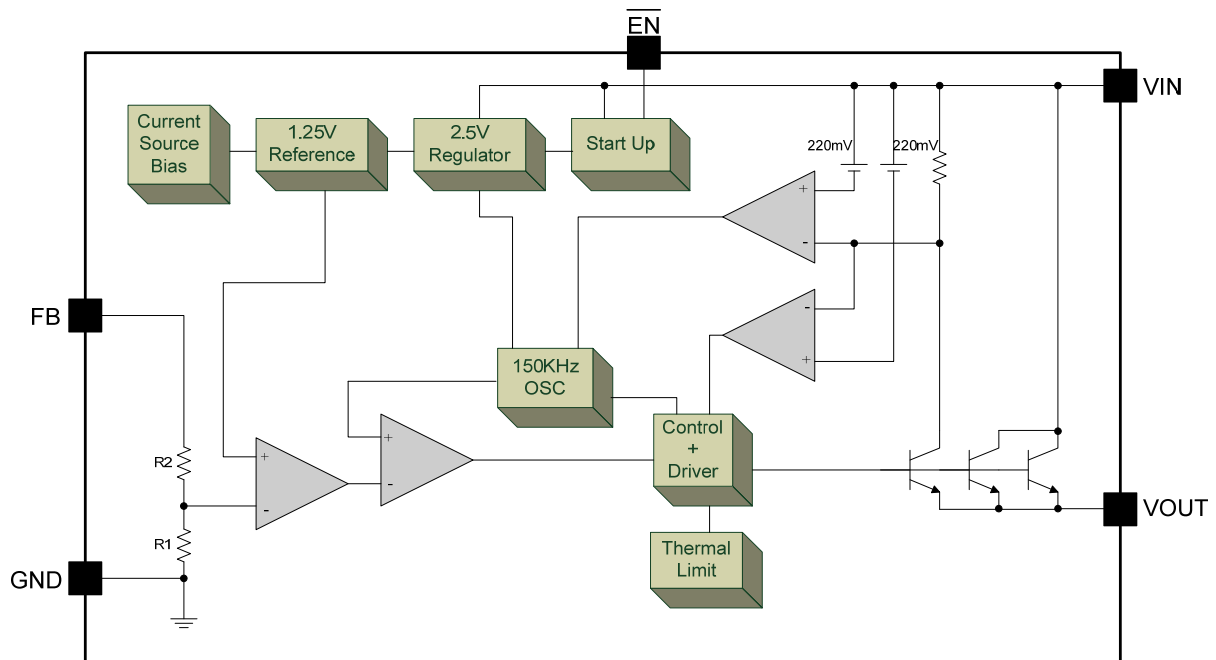

ABSOLUTE MAXIMUM RATINGS (Note 1)

Symbol	Parameter	Maximum	Unit
P _D	Power Dissipation	Internally Limited	-
V _{IN}	Maximum Supply Voltage	45	V
$\overline{\text{EN}}$	$\overline{\text{EN}}$ Pin Input Voltage	$-0.3\text{V} < V_{\text{IN}} < +0.3$	V
θ_{JA}	Thermal resistance junction to Ambient (Note 2)	40	°C/W
T _J	Operating Junction Temperature Range	-40~+125	°C
T _{STG}	Storage Temperature Range	-65~+150	°C
ESD	Minimum EDS Rating (C=100pF, R=1.5K Ω)	2000	V
T _{LEAD}	Lead Soldering Temperature (Soldering, 10 sec)	260	°C

Note 1: Absolute Maximum Ratings indicate limits beyond which damage to the device may occur. Operating Ratings indicate conditions for which the device is intended to be functional, but do not guarantee specific performance limits. For guaranteed specifications and test conditions, see the Electrical Characteristics

Note 2: Exceeding these ratings could cause damage to the device. All voltages are with respect to Ground. Currents are positive into, negative out of the specified terminal.

θ_{JA} : Thermal Resistance-Junction to Ambient, Junction Temperature Calculation: $T_J = T_A + (P_D \times \theta_{JA})$

The θ_{JA} numbers are guidelines for the thermal performance of the device/PC-board system.

All of the above assume no ambient airflow.

ELECTRICAL CHARACTERISTICS($T_J = 25^\circ\text{C}$ Unless otherwise noted)

Unless otherwise specified, these specifications apply $V_{IN} = 12\text{V}$ for 3.3V and 5.0V options, and $V_{IN} = 24\text{V}$ for 12V versions, $I_{LOAD} = 500\text{mA}$

Symbol	Parameter		Test Conditions	Min	Typ	Max	Unit
V_{OUT}	3.3V	Output Voltage	$4.75\text{V} \leq V_{IN} \leq 40\text{V}$ $0.2\text{A} \leq I_{OUT} \leq 3\text{A}$	3.168	3.300	3.432	V
	5.0V		$7\text{V} \leq V_{IN} \leq 40\text{V}$ $0.2\text{A} \leq I_{OUT} \leq 3\text{A}$	4.750	5.000	5.250	
	ADJ		$4.5\text{V} \leq V_{IN} \leq 40\text{V}$ $0.2\text{A} \leq I_{OUT} \leq 3\text{A}$	1.193	1.230	1.267	
η	3.3V	Efficiency	$V_{IN} = 12\text{V}, I_{LOAD} = 2\text{A}$	-	73	-	%
	5.0V		$V_{IN} = 12\text{V}, I_{LOAD} = 2\text{A}$	-	80	-	
	ADJ		$V_{IN} = 12\text{V}, I_{LOAD} = 2\text{A}$	-	73	-	
I_B	Feedback Bias Current		$V_{FB}=1.3\text{V}$ (Adjustable Version Only)	-	10	50	nA
V_{SAT}	Saturation Voltage		$I_{out}=3\text{A}$, (Note 3, 4)	-	1.16	1.4	V
f_o	Oscillator Frequency		(Note 5)	127	150	173	KHz
DC	Duty Cycle (ON)		(Note 6)	-	100	-	%
DC	Duty Cycle (OFF)		(Note 7)	-	0	-	%
I_L	Output Leakage Current		Output=0V, (Note 3, 4,)	-	-	100	μA
			Output=-0.9V	-	2	-	mA
I_Q	Quiescent Current		(Note 7)	-	5	-	mA
I_{STBY}	Standby Current		\overline{EN} Pin=5V(OFF)	-	70	200	μA
V_{IH}	\overline{EN} Pin Input Level		Low (ON)	-	1.3	0.6	V
V_{IL}			High (OFF)	2.0	1.3	-	
I_H			$V_{LEVEL} = 2.5\text{V}$ (OFF)	-	5	15	μA
I_L			$V_{LEVEL} = 0.5\text{V}$ (ON)	-	0.02	5	

Note 3: No diode, inductor or capacitor connected to output pin.

Note 4: Feedback pin removed from output and connected to 0V to force the output transistor switch ON.

Note 5: The switching frequency is reduced when the second stage current limit is activated

Note 6: Feedback pin removed from output and connected to 0V to force the output transistor switch ON.

Note 7: Feedback pin removed from output and connected to 12V for the 3.3V, 5V, and the ADJ. version.

The products and product specifications contained herein are subject to change without notice to improve performance characteristics. Consult us, or our representatives before use, to confirm that the information in this datasheet is up to date

We assume no responsibility for any infringement of patents, patent rights, or other rights arising from the use of any information and circuitry in this datasheet.

TYPICAL APPLICATIONS

- ◆ Adjustable Output Voltage

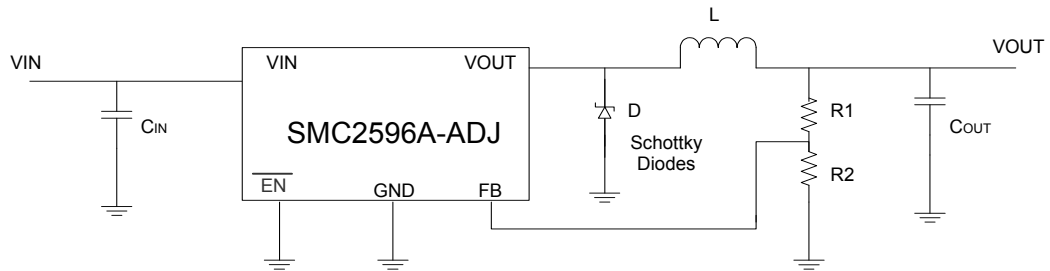

$$V_{OUT} = V_{REF} \times \left(1 + \frac{R1}{R2}\right)$$

$C_{IN} = 470\mu F$, Aluminum Electrolytic
 $C_{OUT} = 220\mu F$, 25V, Aluminum Electrolytic
 $D = \text{Schottky, } 5A/40V$
 $L = 33\mu H$

- ◆ Figure 2 Fixed Voltage Regulator:

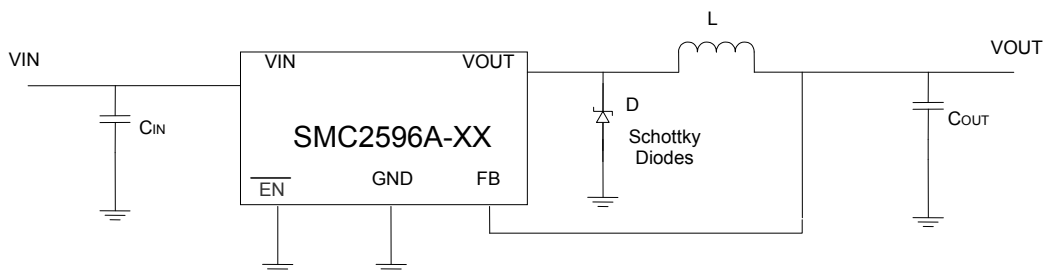

$C_{IN} = 470\mu F$, Aluminum Electrolytic
 $C_{OUT} = 220\mu F$, 25V, Aluminum Electrolytic
 $D = \text{Schottky, } 5A/40V$
 $L = 33\mu H$

TYPICAL CHARACTERISTICS (25°C Unless Note)

Switch Saturation Voltage

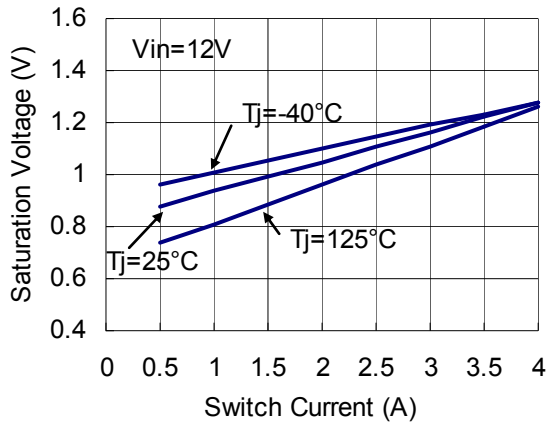

Switch Current Limit

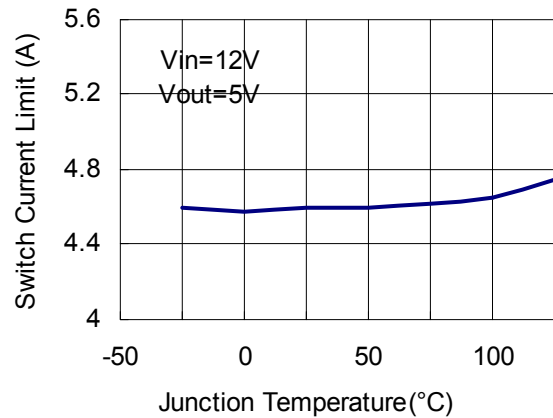

Dropout Voltage

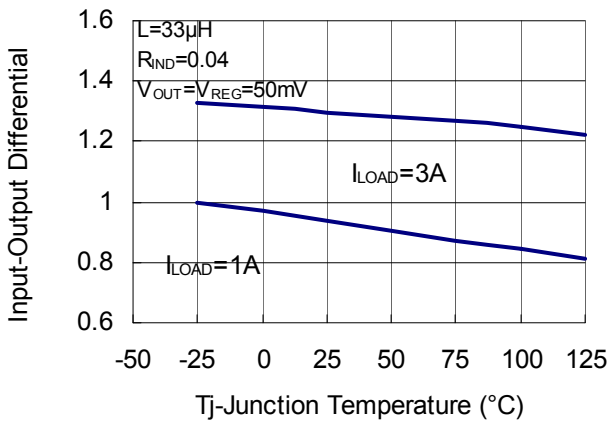

Operating Quiescent Current

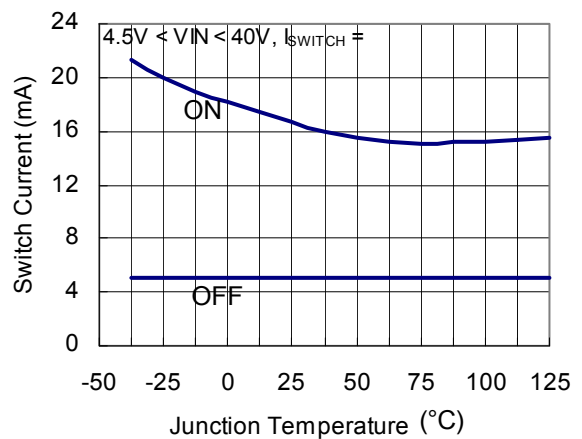

Minimum Operating Supply Voltage

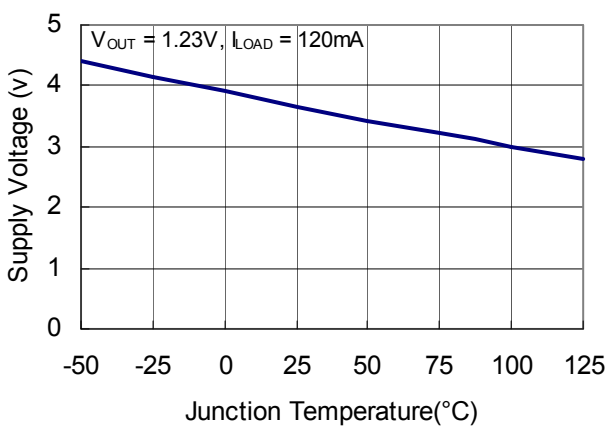

Shutdown Quiescent Current

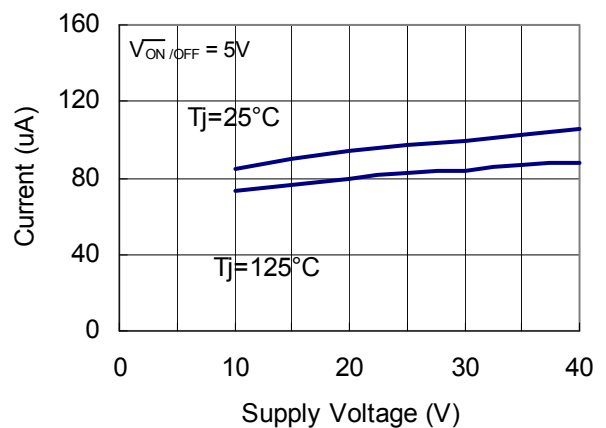

TYPICAL CHARACTERISTICS (25°C Unless Note)

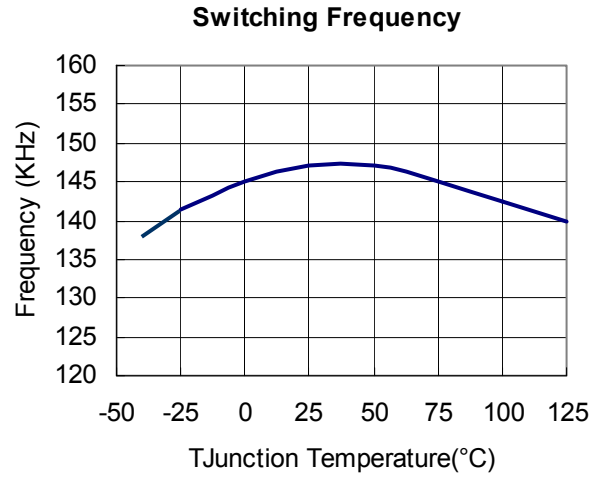
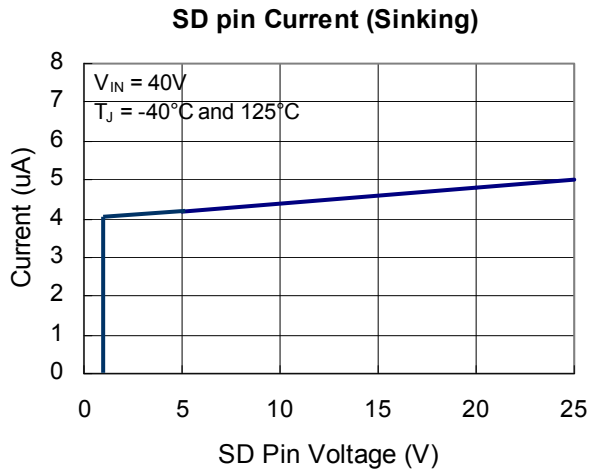

TO263-5L

PACKAGE

Symbol	Dimensions In Millimeters		Dimensions In Inches	
	Min.	Max.	Min.	Max.
A1	0.050	0.250	0.002	0.010
A2	4.460	4.670	0.176	0.184
A3	1.470	1.570	0.058	0.062
b	0.790	0.890	0.031	0.035
b1	0.780	0.840	0.031	0.033
c	0.370	0.450	0.015	0.018
c1	0.360	0.400	0.014	0.016
c2	1.270 BSC		0.050 BSC	
D	10.000	10.200	0.394	0.402
D1	8.000 REF		0.315 REF	
D2	7.000 REF		0.276 REF	
E	14.650	15.050	0.577	0.593
E1	8.300	8.500	0.327	0.335
E2	5.800 BSC		0.228 REF	
e	1.700 BSC		0.067 BSC	
L	1.840	2.240	0.072	0.088
L1	1.650 BSC		0.065 BSC	
θ	0°	8°	0°	8°

DIMENSIONS

